



LUMINARIAS LED

2024



GLS Global Lighting Solutions e Ilukon son marcas registradas de Global Lighting Solutions S.A. Reservados todos los derechos.

GLS se reserva el derecho de modificar las especificaciones o discontinuar cualquier producto de este catálogo sin notificación previa y no será responsable de ninguna consecuencia que resulte de esta publicación.

GLS Global Lighting Solutions e Ilukon are registered trademarks of Global Lighting Solutions S.A. All rights reserved

Product availability, specifications and compliances are subject to change without notice and will not be responsible for any consequences resulting for this publication.

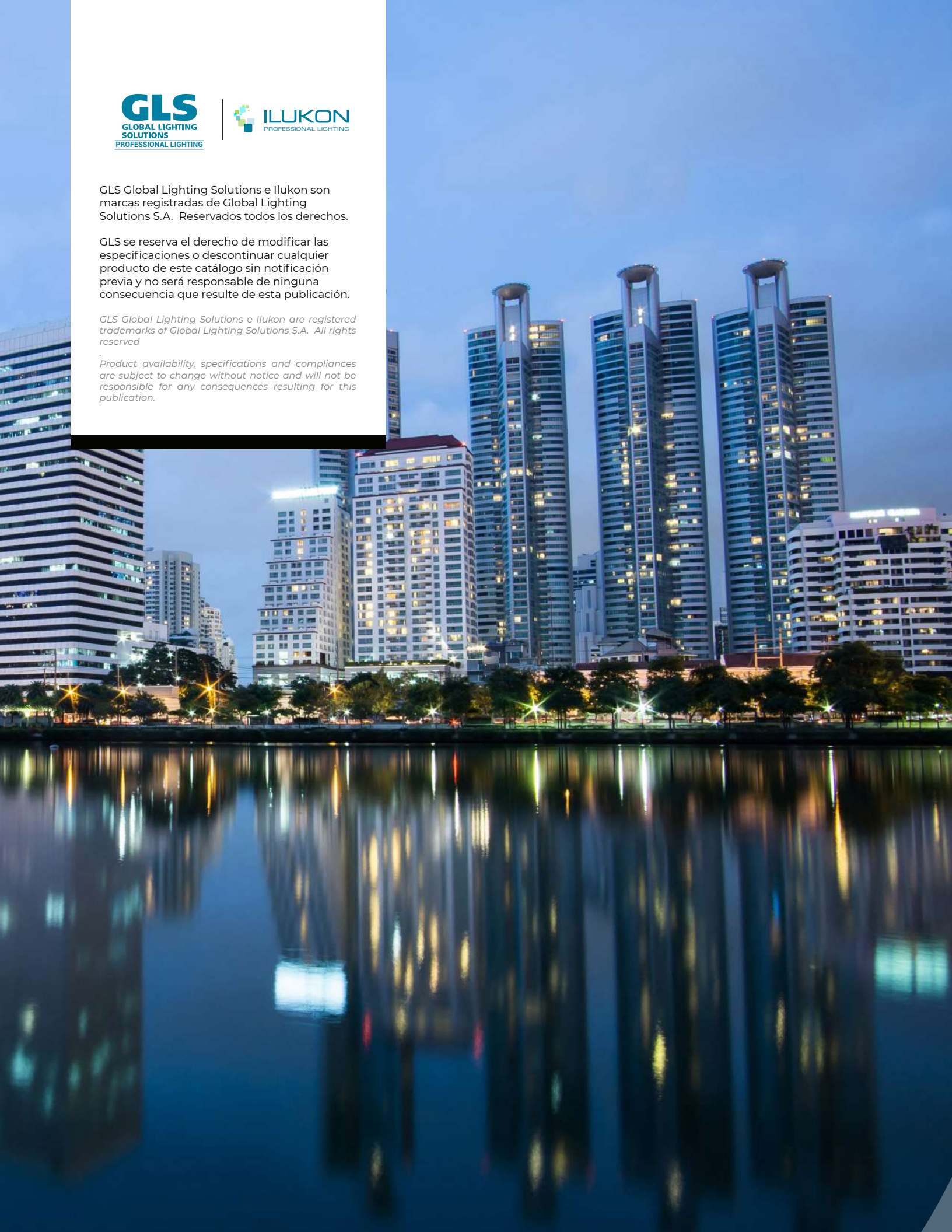

¡Nuestra marca es luz, nuestra marca es innovación!

Con más de 15 años en el mercado, Global Lighting Solutions es una empresa que crea y distribuye soluciones en iluminación con la más alta tecnología, calidad y responsabilidad ambiental.

Con presencia en más de 16 países, en Centroamérica y Caribe, somos distribuidores máster de las prestigiosas marcas **LEDVANCE** e **ILUKON**.

Contamos además con una red de aliados estratégicos en los mercados de Estados Unidos, Europa y Canadá, con los cuales potenciamos nuestra capacidad de responder a sus necesidades específicas de iluminación.

Nuestro equipo de asesores expertos en iluminación está listo para brindarle asesoría y un servicio personalizado, ágil y de primera, para sus proyectos y necesidades.

Our Brand is light; our Brand is innovation!

For over 15 years, Global Lighting Solutions has brought a high level of quality, innovation and environmental responsibility to provide the best lighting solutions.

*Our company operates in more than 16 countries in Central America and Caribbean, we are proud to represent and support the best brands in the lighting business such as **LEDVANCE** and **ILUKON**.*

We use our network of strategic allies around the world to provide effective solutions to our clients and guarantee the response to their specific needs.

Our team of experts have an extensive background in lighting applications and we are focused to deliver customized, agile and first-class solutions to the clients.





ILUKON
PROFESSIONAL LIGHTING

Los profesionales de la iluminación

Orgullosamente hemos desarrollado la marca **ILUKON**, para ofrecer una amplia gama de luminarias y lámparas LED.

Todos nuestros productos responden a los más altos estándares de fabricación, calidad y ahorro energético.

Nos preocupamos por entregar calidad y respaldo certificando nuestros productos bajo las reconocidas normas internacionales UL, ETL, NOM y otras, según las necesidades de nuestros clientes.

Lighting Professionals

*We have proudly developed **ILUKON** on bringing a wide range of luminaires and led lamps.*

All our products meet the highest standards of manufacturing, quality and energy savings.

We are committed to demonstrating the highest standards of product quality and support.

Our products comply with applicable international requirements, such as UL, ETL, NOM and others, according to the needs of our customers.

ÍNDICE

PRODUCTOS SMART SMART PRODUCTS

- 08** | ILUKON Cloud Smart
- 09** | ILUKON Morpho Smart
- 10** | ILUKON Downlight Smart ILUKON
- 11** | Bombillo A19 Smart

ALUMBRADO PÚBLICO STREET LIGHTING

- 14** | Streetlight XCS
- 15** | Streetlight Echo
- 16** | Streetlight Performer
- 17** | Streetlight KY3

DEPORTIVAS SPORTS

- 20** | Arena Led SPX G4

SOLARES SOLAR

- 23** | Solaris Streetlight
- 24** | Solaris Floodlight
- 25** | Solaris Aplique Mini
- 26** | Solaris Flat
- 27** | Solaris Bollard
- 28** | Solaris Garden
- 29** | ILUKON Street Solar Dinamo Pro
- 30** | ILUKON Street Solar Equinox
- 31** | Solaris Led Cubo
- 32** | ILUKON Street Solar Wing
- 33** | Solaris Wall Brick
- 34** | Solaris Wall Cristal
- 35** | Solaris Wall Flat
- 36** | Solaris Wall Mini

EXTERIOR OUTSIDE

- 39** | Parklight Deco Led SCCT
- 40** | Floodlight Slim Led
- 41** | Security Led G2
- 42** | Wall Pack Led Mini Wall
- 43** | Pack Led
- 44** | ILUKON Bollard Led

EMERGENCIA EMERGENCY

- 47** | Emergency Downlight
- 48** | Twin led
- 49** | Square Led
- 50** | Salida Led Bi-Color
- 51** | Salida ES Led
- 52** | Salida 2H Led

INDUSTRIAL INDUSTRIAL

- 55** | High Bay TLXS
- 56** | High Bay Saturn
- 57** | High Bay Titan Echo
- 58** | WP Acqua Led UL
- 59** | WP Led ECO
- 60** | WP Led SM IP67
- 61** | WP Led GD IP67
- 62** | WP SM IP67 Led T8
- 63** | WP GD IP67 T8
- 64** | WP Echo Tubo LED
- 65** | Strip Flat Led T8
- 66** | Cinta Led Rollo
- 67** | Perfil Aluminio ILUKON
- 68** | Luver Led
- 69** | Linear Line Echo Led

PROFESIONAL PROFESSIONAL

- 73** | Panel Backlight SCCT
- 74** | Panel Backlight
- 75** | Panel Cleanroom
- 76** | Troffer Led Pro G2 UL
- 77** | Troffer Led
- 78** | Troffer Led T8
- 79** | Linear Led SCCT Pro
- 80** | Downlight DLX Pro+ UL
- 81** | ILUKON CLD
- 82** | Linear Medical

RESIDENCIAL RESIDENTIAL

- 85** | Spot Echo
- 86** | Downlight Slim RD
- 87** | Downlight Slim SQ
- 88** | Downlight Surface RD
- 89** | Downlight Evo
- 90** | Turtle Light Led
- 91** | Cinta Led Kit
- 92** | ILUKON Fantasy String Led

LÁMPARAS LAMPS

- 95** | Tubo Led ILUKON 9W Y 18W CE
- 96** | Tubo Led ILUKON 9W
- 97** | Tubo Led ILUKON 18W
- 98** | Tubo Led ILUKON PC
- 99** | Tubo Led ILUKON T5 UL Tubo Led
- 100** | ILUKON T8 UL Tubo Led
- 101** | ILUKON 96 CE Tubo Led
- 102** | ILUKON 96 UL ILUKON
- 103** | ILUKON Bomb Led CE
- 104** | ILUKON Pro Led A19 Dim UL
- 105** | ILUKON Bomb Led (Refri)
- 106** | ILUKON B Led A60 Sensor
- 107** | ILUKON B Led A60 Emergen
- 108** | ILUKON Led High Wattage
- 109** | ILUKON Pro Led MR16 Dim UL
- 110** | ILUKON Led MR16 GU10
- 111** | ILUKON Led MR16 GU5.3
- 112** | ILUKON Pro Led PAR 20 Dim
- 113** | ILUKON Pro Led PAR 30 Dim
- 114** | ILUKON Pro Led PAR 38 Dim

ACCESORIOS DE EMERGENCIA EMERGENCY ACCESORIES

- 117** | Batería de Emergencia P/Led 8W
- 118** | Batería de Emergencia P/Led 20W
- 119** | Batería de Emergencia P/Led 20W Máx
- 120** | Batería de Emergencia P/Led 40W
- 121** | Batería de Emergencia P/Highbay Led 200W



Productos Smart
Smart Products

Productos Smart / Smart Products

Páginas / Pages: 08-11



ILUKON CLOUD SMART

08



ILUKON MORPHO SMART

09



ILUKON DOWNLIGHT SMART

10



ILUKON BOMBILLO A19 SMART

11

ILUKON CLOUD SMART



Características / Characteristics

Luminaria de sobrepone inteligente controlada por APP Tuya Smart, compatible con los asistentes de voz Alexa, Google Assistant y Siri. APP permite encender, apagar, atenuar, cambiar el color, la temperatura de color, crear escenas, agendar, entre otras funciones. Conexión por WIFI y Bluetooth.

Intelligent surface luminaire controlled by the Tuya Smart APP, compatible with Alexa, Google Assistant and Siri voice assistants.

Tuya APP allows you to turn on, turn off, dim, change the color, the color temperature, create a scene, schedule, among other functions. WIFI and Bluetooth connection.

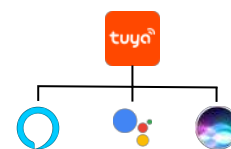

Información Técnica / Technical Information

Especificaciones / Specifications

Código Code	Descripción Description	Potencia Power (W)	TCC CCT (K)	Flujo Luminoso Luminous Flux (lm)	Tensión Voltage (V~)	IRC CRI	Factor de Potencia PF	Ángulo Apertura Beam angle
95500143A	LUM CLOUD SMART ILUK 24W 1560LM RGBW 120-240V SOB	24	2700-6000 / RGB	1560	120-240	80	0.5	180°

Dimensiones Generales / General Dimensions

Modelo Model	A(mm)	B(mm)
24W	380	60

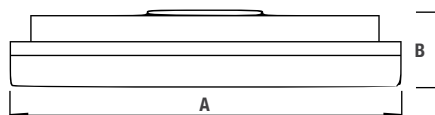

Información de empaque / Packing information

Modelo Model	CBM (Master)	Unidades por caja Units per box	Dimensiones caja (cm) Box dimensions (cm)
24W	0.0992	10	40 x 40 x 62



ILUKON MORPHO SMART



Características / Characteristics

Luminaria de sobreponer inteligente controlada por APP Tuya Smart, compatible con los asistentes de voz Alexa, Google Assistant y Siri. APP permite encender, apagar, atenuar, cambiar el color, la temperatura de color, crear escenas, agendar, entre otras funciones. Conexión por WIFI y Bluetooth.

Intelligent surface luminaire controlled by the Tuya Smart APP, compatible with Alexa, Google Assistant and Siri voice assistants.

Tuya APP allows you to turn on, turn off, dim, change the color, the color temperature, create a scene, schedule, among other functions. WIFI and Bluetooth connection.



Información Técnica / Technical Information

Especificaciones / Specifications

Código Code	Descripción Description	Potencia Power (W)	TCC CCT (K)	Flujo Luminoso Luminous Flux (lm)	Tensión Voltage (V~)	IRC CRI	Factor de Potencia PF	Ángulo Apertura Beam angle
95030146A	LUM MORPHO SMART ILUK 24W 1200LM RGBWW 120-240V SOB	24	2700 / RGB	1200	120-240	80	0.9	180°

Dimensiones Generales / General Dimensions

Modelo Model	A(mm)	B(mm)	C(mm)
24W	175	24	24

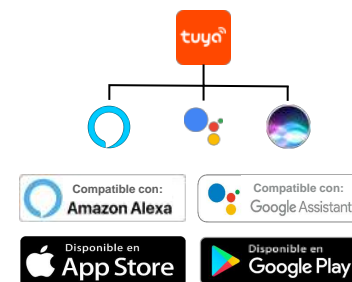

Información de empaque / Packing information

Modelo Model	CBM (Master)	Unidades por caja Units per box	Dimensiones caja (cm) Box dimensions (cm)
24W	0.040	4	30.2 x 44.7 x 28.5



ILUKON Downlight SMART



Características / Characteristics

Luminaria de empotrar inteligente controlada por APP Tuya Smart, compatible con los asistentes de voz Alexa, Google Assistant y Siri.

APP permite encender, apagar, atenuar, cambiar el color, la temperatura de color, crear escenas, agendar, entre otras funciones.

Conexión por WIFI y Bluetooth.

Intelligent recessed luminaire controlled by the Tuya Smart APP, compatible with Alexa, Google Assistant and Siri voice assistants.

Tuya APP allows you to turn on, turn off, dim, change the color, the color temperature, create a scene, schedule, among other functions. WIFI and Bluetooth connection.

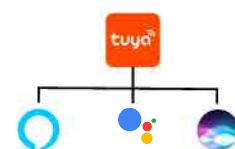

Información Técnica / Technical Information

Especificaciones / Specifications

Código Code	Descripción Description	Potencia Power (W)	TCC CCT (K)	Flujo Luminoso Luminous Flux (lm)	Tensión Voltage (V~)	IRC CRI	Factor de Potencia PF	Ángulo Apertura Beam angle
60672402A	LUM DOWNLIGHT SMART ILUK 10W 800LM RGBW 120V DIM/APP EMP	10	2700-6500 / RGB	800	120	80	0.5	120°

Dimensiones Generales / General Dimensions

Modelo Model	A(mm)	B(mm)	C (Cut out)
10W	53	114	95

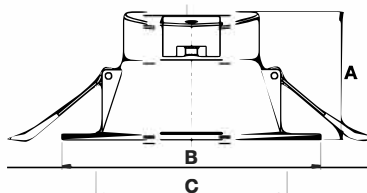

Información de empaque / Packing information

Modelo Model	CBM (Master)	Unidades por caja Units per box	Dimensiones caja (cm) Box dimensions (cm)
10W	0.556	50	61.5 x 35.5 x 25.5





ILUKON BOMBILLO LED A19 SMART



Características / Characteristics

Las bombillas se han vuelto exponencialmente más inteligentes en los últimos años. Ahora puede reemplazar su bombilla incandescente estándar con una variedad de soluciones conectadas que puede controlar con solo unos pocos toques en su teléfono inteligente o tableta. Los bombillos LED con tecnología Smartlite de ILUKON, pueden reemplazar cualquier bombilla tradicional o LED por bombillas inteligentes. Usando Wifi o Bluetooth™ puede conectar todas las bombillas, proporcionando control sobre la iluminación de su hogar desde una ubicación centralizada. La tecnología Tuya™ tiene la capacidad de comunicarse con Alexa™, Google Assistant™ y Siri™.

Light bulbs have grown exponentially smarter in recent years. You can now replace your standard incandescent bulb with a variety of connected solutions you can control with just a few taps on your smartphone or tablet. LED lamps with Smartlite technology ILUKON, can replace any traditional or led bulbs with smart light bulbs. Using Wifi or Bluetooth™ you can connect all of the bulbs, providing control over the lighting in your home from a centralized location. Tuya™ technology has capability to communicate with Alexa™, Google Assistant™ and Siri™.



Información Técnica / Technical Information



Especificaciones / Specifications

Código SKU	Descripción Description	Potencia Power (W)	TCC CCT (K)	Flujo Luminoso Luminous Flux (lm)	Tensión Voltage (V~)	Formato Format	IRC* CRI*	Factor de Potencia PF	Garantía Warranty
95672400A	BOMB SMART WIFI	9W	SCCT / RGB	800lm	120 VAC	A19	> 80	> 0.50	2 años

*IRC no aplica para RGB.
*CRI not applicable for RGB.



A long-exposure photograph of a city street at night. The street is illuminated by modern streetlights, and the background features a large, modern building with a glass facade. Light trails from moving vehicles are visible on the road. A blue wave-like graphic is overlaid on the top half of the image.

Alumbrado Público
Street Lighting

Alumbrado Público / *Street Lighting*

Páginas / Pages: 14-17



STREETLIGHT XCS

14



STREETLIGHT ECHO

15



STREETLIGHT PERFORMER

16



STREETLIGHT KY3

17



Streetlight XCS



Características / Characteristics

Luminaria de carretera eficiente y robusta de alto rendimiento. Con certificación UL y capacidad de atenuación 0-10V. Su óptica de alta eficiencia moldeada con precisión, con chips Led de alta eficacia, está diseñada para dar forma a la distribución, maximizando la eficiencia y el espacio de aplicación.

Efficient and robust high performance street luminaire. UL and 0-10V dimming capability. The precision molded high efficiency optics, with high efficiency LED chips, are designed to shape the distribution, maximizing efficiency and application spacing.



Información Técnica / Technical Information

Especificaciones / Specifications								
Código SKU	Descripción Description	Potencia Power (W)	Flujo Luminoso Luminous Flux (lm)	TCC CCT (K)	Tensión Voltage (V~)	IRC CRI	Factor de Potencia PF	Distorsión Armónica THD
65675270A	LUM STREET PERF XCS ILUK 60/80/100W 142LM/W 850 UL 120-277V 0-10V IP66 IK08	100/80/60	14200 / 11400 / 8600	5000	120-277 VAC	> 80	> 0.90	≤20%

Dimensiones Generales / General Dimensions

Formato Format	L (mm)	W (mm)	H (mm)
100W / 80W / 60W	516	333	92

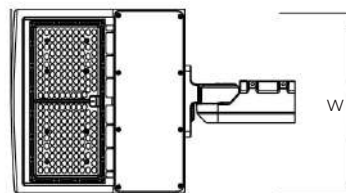
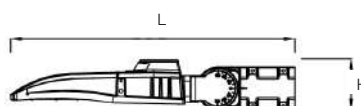



Streetlight Echo



Características / Characteristics

Luminaria de carretera eficiente que ofrece un innovador diseño de gestión térmica. Controlador UL, con capacidad de atenuación 0-10V. IP66 con protección contra sobretensiones de 10KV. Su óptica de alta eficiencia moldeada con precisión, con chips Led Seoul 3030, está diseñada para dar forma a la distribución, maximizando la eficiencia y el espacio de aplicación.

Street luminaire that delivers an innovative thermal management design. The UL Sosen, 0-10V dimming, IP66 driver and 10KV surge protection. The precision molded high efficiency optics, with Seoul 3030 led chips, are designed to shape the distribution, maximizing efficiency and application spacing.

Información Técnica / Technical Information

Especificaciones / Specifications								
Código SKU	Descripción Description	Potencia Power (W)	Flujo Luminoso Luminous Flux (lm)	TCC CCT (K)	Tensión Voltage (V~)	IRC CRI	Factor de Potencia PF	Distorsión Armónica THD
65725021A	LUM STREETLIGHT ECHO 210L750 120-277V 0-10V T3 IK08 100Khrs 150W UL	150	21000	5000	120-277 VAC	> 70	> 0.90	< 15%
65724133A	LUM STREETLIGHT ECHO 336L750 120-277V 0-10V T3 IK08 100Khrs 240W UL	240	33600					

- Cable UL, SJOW, color negro ($\phi 8 \pm 0.3\text{MM}$), $3 \times 0.824\text{MM}^2$, 18AWG, 105°C, 300V (el cable estándar es de 1.2 m, fuera de 1 m) núcleo de cable negro, blanco, verde
- UL wire, SJOW, black ($\phi 8 \pm 0.3\text{MM}$), $3 \times 0.824\text{MM}^2$, 18AWG, 105°C, 300V (Standard wire is 1.2m, outside 1m). Black, white, green wire core.
- Base para fotocelda y fotocelda estándar
- Photobase and Photocell are standard.

Dimensiones Generales / General Dimensions

Formato Format	L (mm)	W (mm)	H (mm)
150 W	485	326	80
240 W	682	328	82

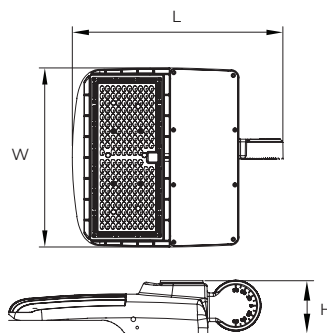

Fotometría / Photometry

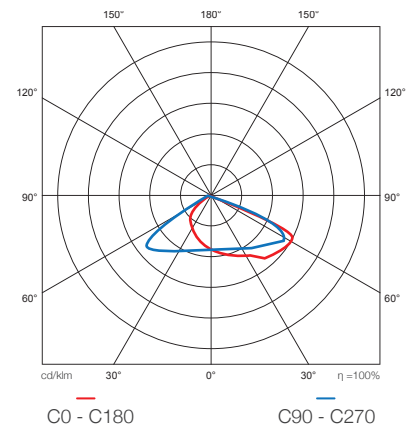



Ilukon Streetlight Performer



Características / Characteristics

Luminaria de carretera de diseño de gestión térmica innovador. Controlador UL, con capacidad de atenuación 0-10V. IP65 con protección contra sobretensiones de 10KV. Óptica de alta eficiencia moldeada con precisión con chips led Seoul Semiconductor 3030.

Street luminaire that delivers an innovative thermal management design. The UL Sosen, 0-10V dimming, IP65 driver and 10KV surge protection. Precision molded high efficiency optic, with Seoul Semiconductor 3030 led chips.

**Aprobación por el laboratorio de eficiencia energética del ICE.*

Información Técnica / Technical Information

Especificaciones / Specifications

Código SKU	Descripción Description	Potencia Power (W)	TCC CCT (K)	Flujo Luminoso Luminous Flux (lm)	Tensión Voltage (V~)	IRC CRI	Factor de Potencia PF	Distorsión Armónica THD
67310014A	LUM STREETLIGHT PERF 126L740 120-277V 0-10V T3 IK09 100Khrs 90W UL	90	4000	12600	120-277 VAC	> 70	> 0.95	< 12%

- Cable UL, SJOW, color negro (Φ8±0.3MM), 3×0.824MM2, 18AWG, 105°C, 300V (el cable estándar es de 1.2 m, fuera de 1 m) núcleo de cable negro, blanco, verde
- UL wire, SJOW, black (Φ8±0.3MM), 3×0.824MM2, 18AWG, 105°C, 300V (Standard wire is 1.2m, outside 1m). Black, white, green wire core.
- Base para fotocelda y fotocelda estándar
- Photobase and Photocell are standard.

Dimensiones Generales / General Dimensions

Formato Format	L (mm)	W (mm)	H (mm)
90 W	558	333	85

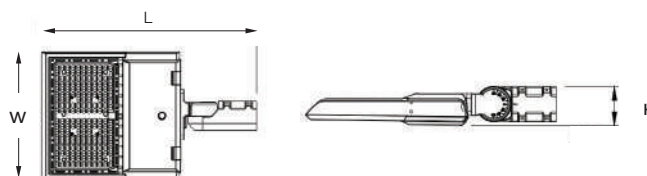

Fotometría / Photometry



Diagrama de Cableado / Wiring Diagram





Streetlight KY3

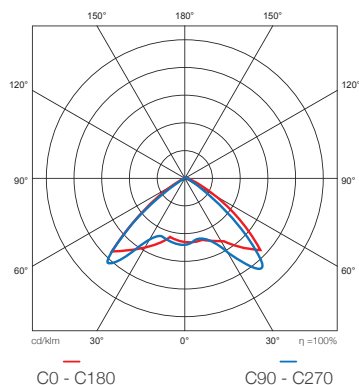
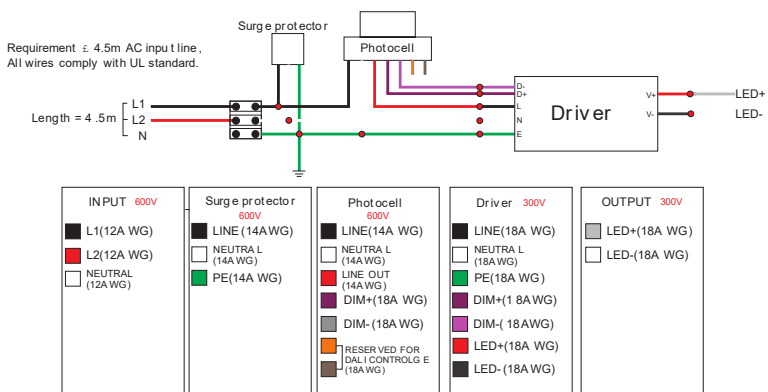

Características / Characteristics

Luminaria de carretera eficiente que ofrece un innovador diseño de gestión térmica. Distribución óptica Tipo II

Street luminaire that delivers an innovative thermal management design. Type II light distribution



Información Técnica / Technical Information

Especificaciones / Specifications

Código Code	Descripción Description	Potencia Power (W)	Flujo Luminoso Luminous Flux (lm)	TCC CCT (K)	Tensión Voltage (V~)	IRC CRI	Factor de Potencia PF	Distorsión Armónica THD
65584054A	LUM STREETLIGHT KY3 50W S/F	50	4000	6500 K	120-277	> 70	>0.9	< 15%
65584055A	LUM STREETLIGHT KY3 100W S/F	100	8000					
65584056A	LUM STREETLIGHT KY3 150W S/F	150	12000					
65584057A	LUM STREETLIGHT KY3 200W S/F	200	16000					
65584059A	LUM STREETLIGHT KY3 50W C/F	50	4000					
65584058A	LUM STREETLIGHT KY3 100W C/F	100	8000					
68015012A	LUM STREETLIGHT KY3 150W C/F	150	12000					
68020016A	LUM STREETLIGHT KY3 200W C/F	200	16000					

- S/F = Sin fotocelda / C/F = con fotocelda, todas tienen base de fotocelda estándar de 3 pines
 - S/F = without photocell / C/F = with photocell, 3 pin standard photobase in all models

Dimensiones Generales / General Dimensions

Formato Format	L (mm)	W (mm)	H (mm)
50 W	500	210	60
100 W	720	270	80
150 W	850	320	80
200 W	950	330	80

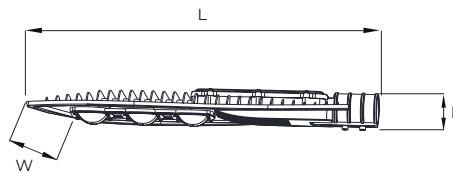

Formato Format	Piezas por caja Pieces / master	Dimensiones de caja Box dimensions (cm)	CBM CBM	Peso bruto Gross weight (kg)
50 W	1	52 x 22 x 8	0.0091	1.4
100 W	1	74 x 28 x 11	0.0227	3.1
150 W	1	87 x 33.5 x 11	0.0320	4.3
200 W	1	96.5 x 34 x 11	0.0360	6





Deportivas
Sports

Deportivas / Sports

Páginas / Pages: 20



ARENA LED SPX G4

20

Arena LED SPX G4



Características / Characteristics

Potente luminaria con certificación UL, ideal para la iluminación profesional de espacios deportivos exteriores, instalaciones de transportes, centros recreativos, puertos. Ángulo de instalación ajustable entre 20° y 120°. Protección contra sobretensiones de 10 kV.

Powerful luminaire UL certified, ideal for professional outdoor sport fields, transport facilities, recreative centers and ports. Installation angle between 20° and 120°. 10Kv surge protector.



Información Técnica / Technical Information

Especificaciones / Specifications

Código SKU	Descripción Description	Potencia Power (W)	TCC CCT (K)	Flujo Luminoso Flux (lm)	Tensión Voltage (V~)	IRC CRI	Factor de Potencia PF	Distorsión Armónica THD
68030042A	LUM ARENA LED SPX SLM7CCT 120-277V 0-10V 40° IK08 100Khrs SPW UL	300 400 500		42000 56000 70000				
68060081A	LUM ARENA LED SPX 870L757 120-277V 0-10V 40° IK08 120Khrs 600W UL	600		87000				
68075010A	LUM ARENA LED SPX 1087L757 120-277V 0-10V 40° IK08 120Khrs 750W UL	750	5700	108750	120-277V	>70	>0.90	<15%
68010001A	LUM ARENA LED SPX 1450L757 120-277V 0-10V 40° IK08 120Khrs 1000W UL	1000		145000				
68012501A	LUM ARENA LED SPX 1740L757 120-277V 0-10V 40° IK08 120Khrs 1200W UL	1200		174000				

- Disponible contra pedido en ángulos de 30° y 80° en potencias de 300W, 400W, 500W y 600W
Custom angles of 30° and 80° for power of 300W, 400W, 500W y 600W available upon request

- Disponible contra pedido en ángulos de 20°, 30°, 60° y 80° en potencias de 750W, 1000W y 1200W
Custom angles of 20°, 30°, 60° and 80° for power of 750W, 1000W and 1200W available upon request

Fotometría / Photometry

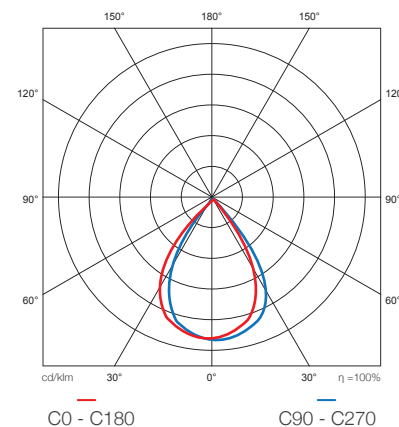

Accesorios / Accessories

Código SKU	Descripción	Imagen
90010101A	PUNTERO LASER PARA LUMINARIA ARENA SPX	Láser opcional Optional laser

Dimensiones Generales / General Dimensions

Formato Format	A (mm)	B (mm)	C (mm)
500 W	410	410	403
600 W	542	533	647
750 W	542	533	647
1000 W	579	571	711
1200 W	579	571	711



Solares
Solar

Solares / Solar

Páginas / Pages: 23-36



SOLARIS STREETLIGHT

23



SOLARIS FLOODLIGHT

24



SOLARIS APLIQUE MINI

25



SOLARIS FLAT

26



SOLARIS BOLLARD

27



SOLARIS GARDEN

28



ILUKON STREET SOLAR DINAMO PRO

29



ILUKON STREET SOLAR EQUINOX

30



SOLARIS LED CUBO

31



ILUKON STREET SOLAR WING

32



SOLARIS WALL BRICK

33



SOLARIS WALL CRISTAL

34



SOLARIS WALL FLAT

35



SOLARIS WALL MINI

36



Solaris Streetlight



IP66

IK06



USO EXTERIOR



DURACION DE BATERIA BATTERY LIFE

Características / Characteristics

Luminaria solar libre de cables y de fácil instalación. Con sensor de presencia integrado y batería de Li-ion. Con encendido automático. Tiene control remoto para funciones de apagado y encendido, atenuación y tem-porizador.

Solar applique luminaire, easy installation and wireless. Integrated PIR motion sensor and Li-ion battery. Automatic turn on function mode. Has a remote control that allows turns on/off, dimmer and timer for 3h, 5h and 8h.



Información Técnica / Technical Information

Especificaciones / Specifications

Código SKU	Descripción Description	*Potencia *Power (W)	Flujo Luminoso Luminous Flux (lm)	TCC CCT (K)	Batería Battery	Ángulo de apertura Beam Angle
60525530A	SOLARIS LED STREETLIGHT 255LM 765 IP66 30W	30	500	6500	5000 mAh, 3.2V	100°
60574408A	SOLARIS LED STREETLIGHT 675LM 765 IP66 60W	60	900		10000 mAh, 3.2V	
60574409A	SOLARIS LED STREETLIGHT 1400LM 765 IP66 90W	90	1400		12000 mAh, 3.2V	
60512016A	SOLARIS LED STREETLIGHT 1600LM 765 IP66 120W	120	1600		18000 mAh, 3.2V	

- * En referencia a incandescente por flujo luminoso
- * According to an incandescent by luminous flux

Dimensiones Generales / General Dimensions

Formato Format	A (mm)	B (mm)
30 W	195	390
60 W	220	485
90 W	240	620
120 W	240	720

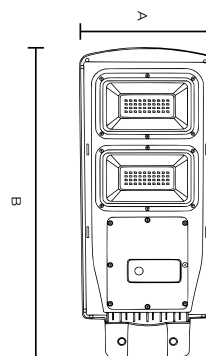

Solaris Floodlight



Características / Characteristics

Luminaria solar libre de cables y de fácil instalación. Con sensor de luz y batería de Li-ion. Tiene control remoto para funciones de apagado y encendido, atenuación y temporizador.

Solar aplique luminaire, easy installation and wireless. Integrated brightness sensor and Li-ion battery. Has a remote control that allows turns on/off, dimmer and timer for 3h, 5h and 8h.



Información Técnica / Technical Information

Especificaciones / Specifications						
Código SKU	Descripción Description	*Potencia Power (W)	Flujo Luminoso Luminous Flux (lm)	TCC CCT (K)	Batería Battery	Ángulo de apertura Beam Angle
60575050A	SOLARIS LED FLOODLIGHT 280LM 765 IP65 30W	30	250	6500	6000 mAh, 3.2V	120°
60575052A	SOLARIS LED FLOODLIGHT 630LM 765 IP65 60W	60	600		18000 mAh, 3.2V	
60575054A	SOLARIS LED FLOODLIGHT 1610LM 765 IP65 200W	200	1610		30000 mAh, 3.2V	

- * En referencia a incandescente por flujo luminoso
- * According to an incandescent by luminous flux

Dimensiones Generales / General Dimensions

Formato Format	A (mm)	B (mm)	C (mm)	D (mm)	E (mm)	F (mm)
30 W	172	148	54	230	340	17
60 W	238	213	78	350	450	17
200 W	352	285	90	360	680	17

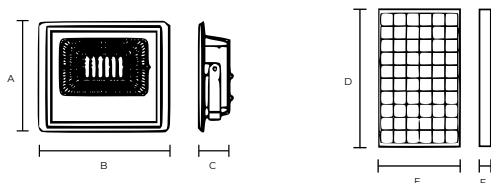



Solaris Aplique Mini



GARANÍA WARRANTY



35000 h



DURACIÓN DE BATERÍA BATTERY LIFE



USO EXTERIOR



SOLAR

Características / Characteristics

Luminaria solar tipo aplique de fácil instalación. Posee luz LED frontal y posterior, su celda solar de alta eficiencia permite recolectar energía del sol, la cual se almacena en su batería de Li-ion. Cuenta con un sensor de presencia integrado para máximo aprovechamiento de la energía.

Easy installation solar light fixture. Front and rear LED light, ist high efficiency solar cell allows it to collect energy from the sun, which is stored in its Li-ion battery. It has an integrated PIR sensor to optimize energy use.



Información Técnica / Technical Information

Especificaciones / Specifications

Código SKU	Descripción Description	Tiempo de carga Charging time (horas)	Flujo Luminoso Luminous Flux (lm)	TCC CCT (K)	Batería Battery	Ángulo de apertura Beam Angle
605220465	SOLARIS LED APLIQUE MINI 220LM 6000K/3000K IP65 35Khrs	10	220	6000 3000	1200 mAh, 3.7V	120°

- La luminaria Solaris Aplique Mini posee 2 modos de funcionamiento que cambian presionando el botón frontal.
- The Solaris Aplique Mini luminaire has 2 operating modes, which change by pressing the front button.

Dimensiones Generales / General Dimensions

Código Code	A (mm)	B (mm)	C (mm)
605220465	145	96	79

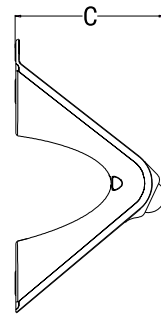
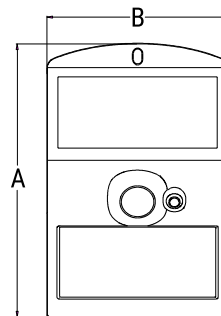

Solaris Flat



Características / Characteristics

Luminaria solar ajustable tipo reflector de fácil instalación. Ajuste del panel led hasta 135° y soporte hasta 360°. Tecnología LED de alta eficiencia. Su celda solar de alta eficiencia permite recolectar energía del sol, la cual se almacena en su batería de Li-ion. Cuenta con sensor de presencia integrado para máximo aprovechamiento de la energía.

Easy installation and adjustable solar light reflector. Adjustable lighting panel until 135° and bracket until 360°. High efficiency LED technology. Its high efficiency solar cell allows it to collect energy from the sun which is stored in its Li-ion battery. It has an integrated PIR sensor to optimize energy use.



Información Técnica / Technical Information

Especificaciones / Specifications

Código SKU	Descripción Description	Tiempo de carga Charging time (horas)	Flujo Luminoso Luminous Flux (lm)	TCC CCT (K)	Batería Battery	Ángulo de apertura Beam Angle
605500665	SOLARIS LED FLAT 500LM 6000K IP65 35Khrs	8	500	6000	2x1500 mAh, 3.7V	120°

- La luminaria Solaris Flat posee 2 modos de funcionamiento que cambian presionando el botón frontal.
- The Solaris Flat luminaire has 2 operating modes, which change by pressing the front button.

Dimensiones Generales / General Dimensions

Código Code	A (mm)	B (mm)	C (mm)	D (mm)
605500665	150	194	232	34

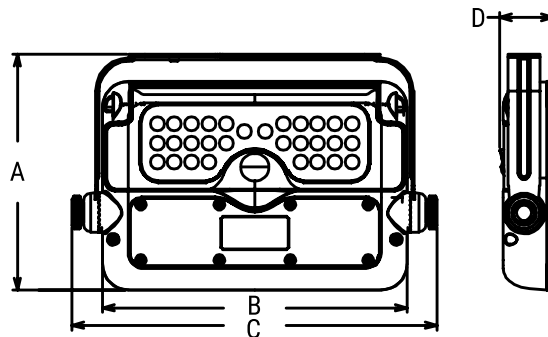

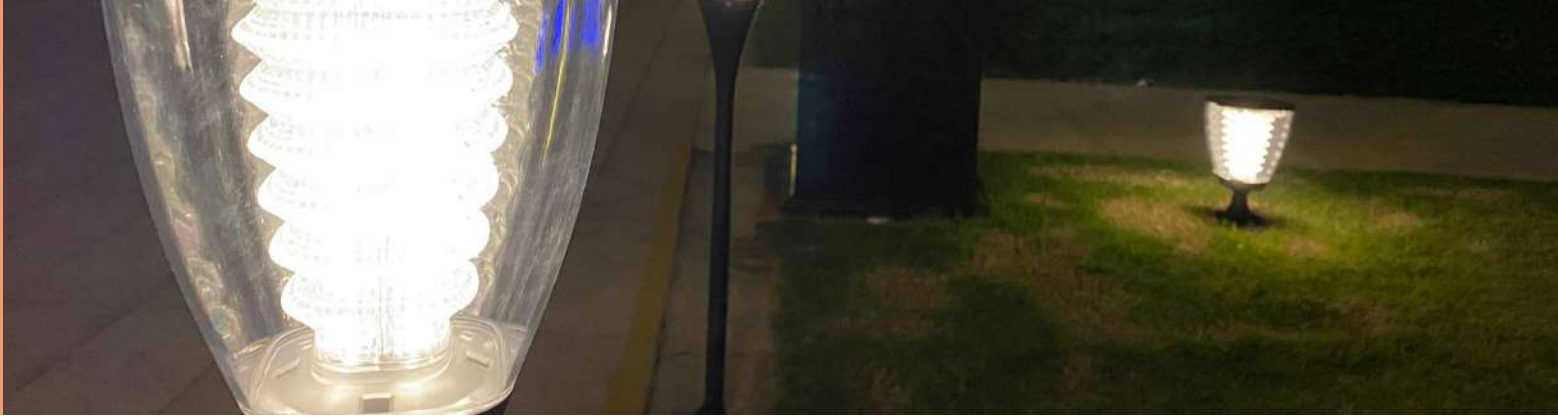

Solaris Bollard



Características / Characteristics

Luminaria solar tipo Bollard de fácil instalación. Posee luz LED cálida para mayor confort, su celda solar de alta eficiencia permite recolectar energía del sol, la cual se almacena en su batería de Li-ion. Led indicador del estado de carga y encendido/apagado automático.

Easy installation solar light fixture. Warm white LED light for greater comfort, its high efficiency solar cell allows it to collect energy from the sun which is stored in its Li-ion battery. Charge status led indicator and automatic turn ON/OFF



Información Técnica / Technical Information

Especificaciones / Specifications

Código SKU	Descripción Description	Tiempo de carga Charging time (horas)	Flujo Luminoso Luminous Flux (lm)	TCC CCT (K)	Batería Battery	Ángulo de apertura Beam Angle
605100365	SOLARIS LED BOLLARD 100LM 3000K IP65 35Khrs	6	100	3000	2000 mAh, 3.7V	120°

- La luminaria Solaris Bollard posee 2 modos de funcionamiento que cambian presionando el botón frontal.
- The Solaris Bollard luminaire has 2 operating modes, which change by pressing the front button.

Dimensiones Generales / General Dimensions

Código Code	A (mm)	B (mm)	C (mm)	D (mm)
605100365	125	779	159	159

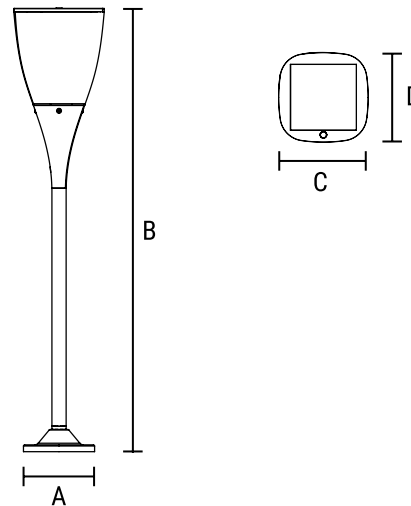



Solaris Garden



2
AÑOS
WARRANTY

IP65

35000 h

2
MESES
NIGHTS

USO
EXTERIOR

SOLAR

Características / Characteristics

Luminaria solar ajustable tipo reflector de fácil instalación, 5 modos de funcionamiento. Su celda solar de alta eficiencia permite recolectar energía del sol, la cual se almacena en su batería de Li-ion. Sensor de microondas integrado para mejor aprovechamiento de la energía y encendido automático.

Easy installation and adjustable solar light fixture, 5 function modes. Its high efficiency solar cell allows it to collect energy from the sun which is stored in its Li-ion battery. It has an integrated PIR sensor to optimize energy use and automatic turn ON.



Información Técnica / Technical Information

Especificaciones / Specifications

Código SKU	Descripción Description	Tiempo de carga Charging time (horas)	Flujo Luminoso Luminous Flux (lm)	TCC CCT (K)	Batería Battery	Ángulo de apertura Beam Angle
605960065	SOLARIS LED GARDEN 960LM 6500K IP65 35Khrs	8	960	6500	2000 mAh, 3.7V	120°

- * En referencia a incandescente por flujo luminoso
- * According to an incandescent by luminous flux

Dimensiones Generales / General Dimensions

Código Code	A (mm)	B (mm)	C (mm)	D (mm)	E (mm)
605960065	380	85	140	95	108





Ilukon Streetlight Solar Dinamo Pro



Características / Characteristics

La luminaria Dinamo Pro es el sistema de iluminación solar LED más eficaz del mundo con una impresionante potencia de hasta 180 lm/w, el cual se creó específicamente para iluminar una amplia gama de aplicaciones. Las tecnologías modernas de energía solar y LED se incorporan a su diseño inteligente y construcción delgada para brindar un rendimiento constante y confiabilidad operativa durante muchos años. Con una excelente tasa e IK09, la construcción resistente está lista para cualquier ambiente. Con sujetadores de aluminio y acero inoxidable de grado marino y certificación para pasar la prueba de cámara salina de 1000 horas (spray de sal), sus componentes internos brindan protección contra la intemperie IP66y una vida útil de más de 2000 ciclos.

En la instalación en poste horizontal o vertical, el ángulo montado es ajustable. Además, está diseñada para sobrevivir a las condiciones climáticas más duras y extremas, incluido el calor abrasador, la lluvia torrencial, el granizo y el frío bajo cero.

The Dinamo Pro luminaire is the world's most efficient solar LED lighting system with an impressive output of up to 180lm/w, specifically created to illuminate a wide range of applications. Modern LED and solar power technologies are incorporated into its smart design and slim construction to provide consistent performance and operational reliability for many years. With an excellent rating and IK09, the rugged construction is ready for any environment. With marine grade aluminum and stainless steel fasteners and certified to pass the 1000 hour salt spray test, its internal components provide IP66 weather protection and a lifespan of 2000+ cycles.

In horizontal or vertical pole installation, the mounted angle is adjustable. Plus, it's built to survive the harshest and most extreme weather conditions, including blistering heat, driving rain, hail and sub-zero cold.



Información Técnica / Technical Information

Especificaciones / Specifications					
Código SKU	Descripción Description	Potencia Power (W)	Flujo Luminoso Luminous Flux (lm)	TCC CCT (K)	IRC CRI
60770023A	LUM STREET ILUK DINAMO P 60W 12KLM 757 IP66	60W	12 000lm	5700	> 70
60770024A	LUM STREET ILUK DINAMO P 80W 16KLM 757 IP66	80W	16 000lm	5700	> 70
60770026A	LUM STREET ILUK DINAMO P 120W 24KLM 757 IP66	120W	24 000lm	5700	> 70

Dimensiones Generales / General Dimensions

Código Code	A (mm)	B (mm)	C (mm)	Tubo Instalación Tube Instalación (Ømm)
60W	1082	407	207	60
80W	1361	407	207	60
120W	1361	855	300	60

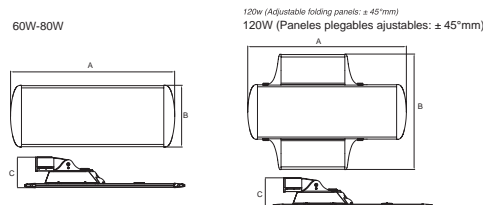

Operación / Operation

Horas Hours	Detección movimiento Motion (% flujo luminoso)	Espera Stand by** (% flujo luminoso)
Primeras 2	100%	30%
Siguientes 3	50%	20%
Siguientes 6	20%	10%
Última	20%	10%

** Después de 15 segundo de no movimiento / after 15 seconds no motion



ESUELAS SCHOOLS



CALLES/ ESTACIONAMIENTOS STREET/PARKING LOTS



PARQUES RECREATIVE AREAS



AUTOPISTAS HIGHWAYS



HOTELÉS HOTELS



AEROPUERTOS AIRPORTS



MUSEOS/ FACHADAS MUSEUMS/FACADES



Ilukon Streetlight Solar Equinox



Características / Characteristics

La luminaria Equinox diseñada para iluminar una amplia gama de aplicaciones, cuenta con una impresionante potencia de hasta 170 kw. Su diseño inteligente y su construcción delgada incorporan la última tecnología LED y de energía solar, que brindan muchos años de rendimiento constante y confiabilidad operativa con una óptica Tipo II para aplicaciones en carreteras y calles y certificada clasificación IK06 e IP65. La batería cuenta con una vida útil de 1700 a 2000 ciclos. El sensor de microondas permite la detección con un montaje de hasta 10 m de altura y un perímetro de 6 a 8 metros con un ángulo de 120° en todas las direcciones. Además, la luminaria Equinox tiene un sensor de movimiento de microondas pasivo incorporado que regula automáticamente la salida de luz LED desde el brillo máximo hasta un nivel más bajo dependiendo de la detección de movimiento alrededor de la luz, especialmente diseñada para soportar los entornos más duros y extremos que ofrece, desde calor abrasador hasta lluvia torrencial, granizo y temperaturas bajo cero.

The Equinox luminaire, designed to illuminate a wide range of applications, has an impressive power of up to 170 kw. Its smart design and slim construction incorporate the latest LED and solar-powered technology, providing many years of consistent performance and operational reliability. With Type II optics for highway and street applications and certified IK06 and IP65 rating, the battery features a long life, useful from 1700 to 2000 cycles. The microwave sensor allows detection with a mounting height of up to 10 m and a perimeter of 6 to 8 meters with an angle of 120° in all directions. Additionally, the Equinox luminaire has a built-in passive microwave motion sensor that automatically regulates the LED light output from maximum brightness to a lower level depending on motion detection around the light, specially designed to withstand the harshest environments, and extremes it offers, from scorching heat to torrential rain, hail and sub-zero temperatures.



Información Técnica / Technical Information

Especificaciones / Specifications

Código SKU	Descripción Description	Potencia Power (W)	Flujo Luminoso Luminous Flux (lm)	TCC CCT (K)	IRC CRI
60574411A	LUM STREETLIGHT EQUINOX 68L757 IP65 40W 27AH CON SENSOR	40W	6800lm	5700	> 70
60574412A	LUM STREETLIGHT EQUINOX 102L757 IP65 60W 27AH CON SENSOR	60W	10200lm	5700	> 70
60574413A	LUM STREETLIGHT EQUINOX 136L757 IP65 80W 33AH CON SENSOR	80W	13600lm	5700	> 70
60574414A	LUM STREETLIGHT EQUINOX 170L757 IP65 100W 42AH CON SENSOR	100W	17000lm	5700	> 70

Dimensiones Generales / General Dimensions

Código Code	A (mm)	B (mm)	C (mm)	Tubo Instalación Tube Instalación (Ømm)
40W	887	400	280	60
60W	887	400	280	60
80W	1160	400	280	76
100W	1435	400	280	76

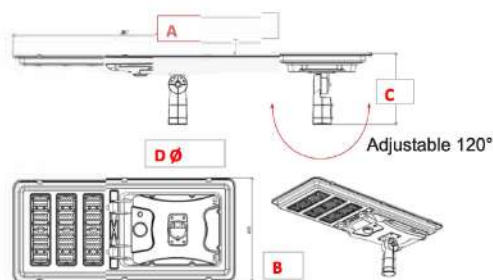

Ciclos de Trabajo (12 horas) / 12 Hour Cycle Lumen Output



Day light (off)

Durante el día (apagado)



Motion

Detectando Movimiento



Stand-by after 30 seconds no motion

Sin detectar movimiento luego de 30 segundos

Hours of operation	Horas de Operación	100%	30%
• First 2 hours	Primeras 2 horas	100%	30%
• Next 3 hours	Siguientes 3 horas	50%	20%
• Next 6 hours	Siguientes 6 horas	20%	10%
• Last hour	Última hora	30%	10%

NOTE: Automatically operates at 30% brightness. When motion is detected, light increases to 100% until no motion is detected for 30 seconds, then returns to 30% brightness.

Nota: Automáticamente la luminaria opera al 30%, cuando el sensor detecta movimiento, el flujo luminoso incrementa al 100%, luego al no haber detectado movimiento por 30 segundos, vuelve a trabajar al 30% del flujo luminoso total.



ESCUELAS SCHOOLS



CALLES/ ESTACIONAMIENTOS STREET/ PARKING LOTS



PARQUES RECREATIVE AREAS



AUTOPISTAS HIGHWAYS



HOTELS HOTELS



AEROPUERTOS AIRPORTS



MUSEOS/ FACHADAS MUSEUMS/ FACADES





Solaris LED CUBO

3 AÑOS GARANTÍA WARRANTY
7 AÑOS GARANTÍA WARRANTY
IP65
IK07
FOTOCELDA
-20 ~ 50°
PIR 120°
PIR 6mts
CE
ROHS

Características / Characteristics

La luminaria Solaris LED Cubo es un diseño minimalista, aportando una iluminación perfecta y alta potencia según su versión, contando con una batería de gran capacidad con protección contra sobrecarga y sobredescarga, adopte una batería nueva, segura y duradera, certificada IP65 a prueba de agua. Adaptable a espacios como jardines, entradas, cercas, balcones, puertas, caminos, paredes, exteriores de edificios, entre otros.

The Solaris LED Cube luminaire is a minimalist design, providing perfect lighting and high power depending on its version, with a large capacity battery with protection against overload and overdischarge, adopte a new, safe and durable battery, certified IP65 waterproof. Adaptable to spaces such as gardens, entrances, fences, balconies, doors, paths, walls, exteriors of buildings, among others.



Información Técnica / Technical Information

Especificaciones / Specifications

Código SKU	Descripción Description	Potencia Power (W)	Flujo Luminoso Flux (lm)	TCC CCT (K)	Tiempo de Carga Charging Time	Tiempo de Encendido Lighting Time	Paquete de Baterías LI-ion Battery Pack	Panel Solar Monocristalino Mono Solar Panel	Altura de Instalación Installation Height
605010150	LUM REFLEC LED SOLARIS ILUK CUBO 10W 1500LM	10	1500	6000K	5H	+60 horas +60 hours	3.7V, 3600mAh, 13.32Wh	4.5W, 5.5V	2 - 4mts
605030450	LUM REFLEC LED SOLARIS ILUK CUBO 30W 4500LM	30	4500		5H				

Dimensiones Generales (mm) / General Dimensions (mm)

Cubo 30W

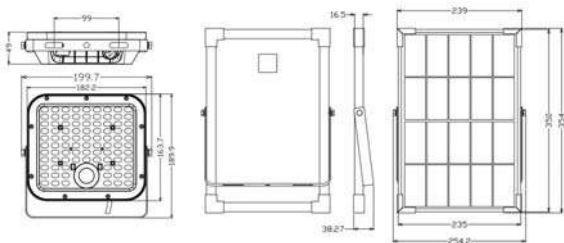

Cubo 10W

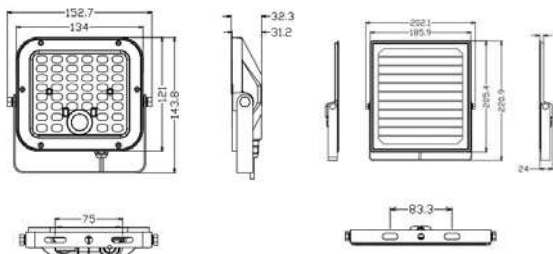

Configuraciones por botón / Optional Work Modes Botton

Cubo 30W

Modo Senso Automático / Auto Sensor Mode

La lámpara se enciende automáticamente por la noche y alcanza el brillo máximo cuando se detecta movimiento en el rango 40Mts. Luego cambia a un brillo más bajo en 60 segundos sin movimiento. Lamp automatically lights up at night and turns to full brightness when motion is detected in the range 40Mts, then turns to lower brightness in 60 seconds of no motion.



Modo Iluminación Continua / Keep Lighting Mode

La lámpara se enciende automáticamente por la noche y mantiene el brillo seleccionado durante 3H59H59, después de lo cual o cuando la carga de la batería es inferior al 30%, la lámpara cambia al modo de sensor automático. Lamp automatically lights up at night and keep selected brightness for 3H59H59, after which or when the battery power is less than 30%, lamp turns to Auto Sensor Mode.



Botón de encendido y apagado / ON/OFF/Switch Mode

Presione primero el botón de la lámpara, la lámpara se encenderá automáticamente y entrará en el modo de sensor automático y el control remoto se activará al mismo tiempo. Luego, los usuarios pueden configurar el modo de trabajo deseado a través del control remoto. / Please press the button on the lamp first, the lamp will automatically turn on and enter Auto Sensor mode, and the remote control is activated at the same time. Then, users can set desired working mode through the remote control.

Cubo 10W

Modo Senso Automático / Auto Sensor Mode

La lámpara se enciende automáticamente por la noche y alcanza el brillo máximo cuando se detecta movimiento en el rango 40Mts. Luego cambia a un brillo más bajo en 60 segundos sin movimiento. Lamp automatically lights up at night and turns to full brightness when motion is detected in the range 40Mts, then turns to lower brightness in 60 seconds of no motion.



Modo Iluminación Continua / Keep Lighting Mode

La lámpara se enciende automáticamente por la noche y mantiene el brillo seleccionado durante 3H59H59, después de lo cual o cuando la carga de la batería es inferior al 30%, la lámpara cambia al modo de sensor automático. Lamp automatically lights up at night and keep selected brightness for 3H59H59, after which or when the battery power is less than 30%, lamp turns to Auto Sensor Mode.



Botón de encendido y apagado / ON/OFF/Switch Mode

Presione primero el botón de la lámpara, la lámpara se encenderá automáticamente y entrará en el modo de sensor automático y el control remoto se activará al mismo tiempo. Luego, los usuarios pueden configurar el modo de trabajo deseado a través del control remoto. / Please press the button on the lamp first, the lamp will automatically turn on and enter Auto Sensor mode, and the remote control is activated at the same time. Then, users can set desired working mode through the remote control.



Solaris LED Streetlight Wing



Características / Characteristics

La luminaria Solaris LED Streetlight Wing es un diseño todo en uno, con una distribución de iluminación profesional de 140° x 70° de haz de ángulo, logrando un área de iluminación mucho mayor. Además, cuenta con un brazo para ajustar la luminaria de 0 a 90° para una máxima flexibilidad de carga solar. Maximizando su uso, cuenta también con un control remoto, ajustando tiempo de funcionamiento y cantidad de flujo luminoso. El Panel solar es de grado A con vidrio laminado, de gran tamaño, con un 21%+ de alta conversión para una carga más rápida, y con más de 20 años de vida útil. La Batería incorporada es de LiFePO4 de alta calidad con gran capacidad, 2000 ciclos, con protección contra sobrecarga y sobredescarga, segura y duradera. La Carcasa de aluminio, resistente y duradera, IP65 resistente al agua e IK08 contra impactos.

The Solaris LED Streetlight Wing luminaire is an all-in-one design, with a professional lighting distribution of 140° x 70° beam angle, achieving a much larger lighting area. Additionally, it features an arm to adjust the luminaire from 0 to 90° for maximum solar charging flexibility. Maximizing its use, it also has a remote control, adjusting the operating time and amount of luminous flux. Solar Panel is Grade A with laminated glass, oversized, 21%+ high conversion for faster charging, and over 20 years lifespan. Built-in Battery is high quality LiFePO4 with large capacity, 2000 cycles, with over charge and over discharge protection, safe and durable. The aluminum housing, resistant and durable, IP65 waterproof and IK08 against impacts.



Información Técnica / Technical Information

Especificaciones / Specifications

Código SKU	Descripción Description	Potencia Power (W)	Flujo Luminoso Flux (lm)	TCC CCT (K)	Tiempo de Carga Charging Time	Tiempo de Encendido Lighting Time	Paquete de Baterías LiFePO4 Battery Pack	Panel Solar Monocristalino Mono Solar Panel	Altura de Instalación Installation Height
605040650	LUM STREETLIGHT LED SOLARIS ILUK WING 40W 6500LM	40	6500	6000	7H	Modo de iluminación mantenida: 35 horas Modo sensor automático: 60 horas	76.8Wh/12.8V, 6AH	22W/18V	4-6m
605060100	LUM STREETLIGHT LED SOLARIS ILUK WING 60W 10KLM	60	10500			Keep Lighting Mode: 35 hours Sensor Mode: 60 hours	115.2Wh/9.6V, 12AH	28W/17.5V	4-6m
605080120	LUM STREETLIGHT LED SOLARIS ILUK WING 80W 12KLM	80	12500			153.6Wh/12.8V, 12AH	42W/17.5V	4-6m	

Dimensiones Generales / General Dimensions

Formato Format	L (mm)	W (mm)	H (mm)	Ø(mm)
40W	507	287	230	60
60W	612	331	230	60
80W	853	349	245	60

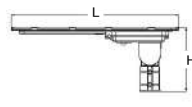

On/Off / Switch

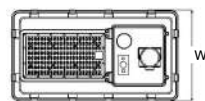

Presione el botón de la lámpara para encenderla y seleccionar el modo de trabajo.
Presione por primera vez, la lámpara se enciende y ingresa al modo Mantener Iluminación;
Presione por segunda vez, la lámpara ingresa al modo de sensor automático;
Presione por tercera vez, la lámpara se apaga.

Please press the button on the lamp to turn on the lamp and select working mode.
Press 1st time, lamp turns on and enters Keep Lighting Mode;
Press 2nd time, lamp enters Auto Sensor Mode;
Press 3rd time, lamp turns off.

Configuraciones por botón / Optional Work Modes Botton

Modo Sensor Automático / Auto Sensor Mode

La lámpara se enciende automáticamente por la noche y alcanza el brillo máximo cuando se detecta movimiento en el rango ≤8Mtrs. luego cambia a un brillo más bajo en 20 segundos sin movimiento.
Lamp automatically lights up at night and turns to full brightness when motion is detected in the range ≤8Mtrs, then turns to lower brightness in 20 seconds of no motion.



Modo Iluminación Mantenida / Keep Lighting Mode

La lámpara se enciende automáticamente por la noche y mantiene el 60% de brillo durante 5 horas, después de lo cual la lámpara cambia al modo de sensor automático.
Lamp automatically lights up at night and keep 60% brightness for 5 hours, after which lamp turns to Auto Sensor Mode.



ESCUELAS
SCHOOLS



CALLES / ESTACIONAMIENTOS
STREET / PARKING LOTS



PARQUES
RECREATIVE AREAS



AUTOPISTAS
HIGHWAYS



HOTELES
HOTELS



AEROPUERTOS
AIRPORTS



MUSEOS / FACHADAS
MUSEUMS / FACADES

GLS
GLOBAL LIGHTING
SOLUTIONS
PROFESSIONAL LIGHTING

ILUKON
PROFESSIONAL LIGHTING



Solaris LED Wall Brick

Características / Characteristics

La luminaria Solaris LED Wall Brick es un diseño conceptual minimalista, de aspecto elegante, aportando una iluminación perfecta y decorado lumínico en paredes, contando con una batería de gran capacidad con protección contra sobrecarga y sobredescarga, adopte una batería nueva, segura y duradera, certificada IP65 a prueba de agua. Adaptable a espacios como jardines, entradas, cercas, balcones, puertas, caminos, paredes, exteriores de edificios, entre otros.

Solaris LED Wall Brick luminaire is a minimalist conceptual design, with an elegant appearance, providing perfect lighting and light decoration on walls, counting on a large capacity battery with protection against overload and over discharge, adopt a new, safe and durable battery, certified IP65 waterproof. Adaptable to spaces such as gardens, fences, balconies, doors, paths, walls, building exteriors, among others.



Información Técnica / Technical Information

Especificaciones / Specifications

Código SKU	Descripción Description	Potencia Power (W)	Flujo Lumínico Flux (lm)	TCC CCT (K)	Tiempo de Carga Charging Time	Tiempo de Encendido Lighting Time	Paquete de Baterías Li-Ion Battery Pack	Panel Solar Monocristalino Mono Solar Panel	Altura de Instalación Installation Height
605003350	LUM REFLEC LED SOLARIS ILUK WALL BRICK 3W 350LM	3	350	6000K	5H	2-4 Noches 2-4 Nights	18650/3.7V/1200mA	1.15W/5.5V	1-3m
605006800	LUM REFLEC LED SOLARIS ILUK WALL BRICK 6W 800LM	6	800	6000K	8H	2-4 Noches 2-4 Nights	3.7V 3000mAh 11.1Wh	2.8W/5.5V	2-4m

Dimensiones Generales (mm) / General Dimensions (mm) Brick

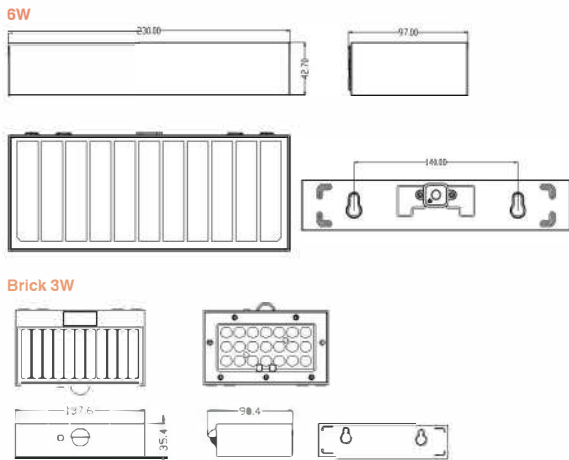

Configuraciones por botón / Optional Work Modes Boton

Brick 6W

Modo A / Mode A
 Cuando la energía de la batería es superior al 30%, la lámpara se enciende automáticamente por la noche y alcanza el brillo máximo cuando se detecta movimiento en el rango de 6 metros, luego se atenúa al 5% de brillo después de 20 segundos sin movimiento.
 Cuando la energía de la batería es inferior al 30%, la lámpara se enciende automáticamente por la noche y alcanza su máximo brillo cuando se detecta movimiento en el rango de 6 metros y luego se apaga después de 20 segundos sin movimiento.
 When battery power is more than 30%, lamp automatically light-up at night and turns to full brightness when motion is detected in the range of 6 meters, then after 20 seconds without movement, the lamp returns to 5% brightness after 20 seconds of no motion.
 When battery power is less than 30%, lamp automatically turns on at night and turns to full brightness when motion is detected in the range of 6 meters, then turns off after 20 seconds of no motion.

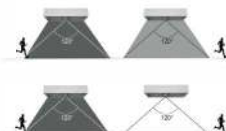

Modo B / Mode B
 La lámpara se enciende automáticamente por la noche y mantiene el 50% de brillo, después de 5 horas cuando la energía de la batería es inferior al 30%, la lámpara pasa al modo de ahorro de energía, luego se apaga después de 20 segundos sin movimiento.
 Lamp automatically lights up at night and keeps 50% brightness, after 5 hours or when battery power is less than 30%, lamp turns to energy saving mode, lamp automatically turns off to full brightness when motion is detected in the range of 6 meters, then turns off after 20 seconds of no motion.



Botón de encendido y apagado y modos de operación / ON/OFF/Switch Work Mode
 Presione el botón por primera vez, la lámpara se enciende y ingresa al Modo A. / Press the button 1st time, the lamp turns on and enters Mode A.
 Presione el botón por segunda vez, la lámpara se atenúa una vez y cambia al Modo B. / Press the button 2nd time, the lamp turns on and turns to Mode B.
 Presione el botón por tercera vez, la lámpara se apaga. / Press the button 3rd time, lamp turns off.

Brick 3W

Modo A / Mode A
 La lámpara se enciende automáticamente por la noche y alcanza el brillo máximo cuando se detecta movimiento en el rango de 6 metros, luego se atenúa para reducir el brillo (o se apaga) después de 10 segundos sin movimiento.
 Lamp automatically lights up at night and turns to full brightness when motion is detected in the range of 6 meters, then turns to lower brightness (or turns off) after 10 seconds of no motion.



Modo B / Mode B
 La lámpara se enciende automáticamente por la noche y alcanza el brillo máximo cuando se detecta movimiento en el rango de 6 metros, luego se atenúa para reducir el brillo (o se apaga) después de 10 segundos sin movimiento.
 Lamp automatically lights up at night and turns to full brightness when motion is detected in the range of 6 meters, then turns to lower brightness (or turns off) after 10 seconds of no motion.



Botón de encendido y apagado y modos de operación / ON/OFF/Switch Work Mode
 1. Presione el botón por primera vez, la luz superior parpadeará una vez, la lámpara ingresa al Modo A. / Press the button 1st time, the upper light flashes once, the lamp enters Mode A.
 2. Presione el botón por segunda vez, la luz superior parpadeará dos veces, la lámpara ingresa al Modo B. / Press the button 2nd time, the upper light flashes twice, the lamp enters Mode B.
 3. Presione el botón por tercera vez, la lámpara parpadeará 3 veces y la lámpara se apaga. / Press the button 3rd time, the upper light flashes 3 times, lamp turns off.





Solaris LED Wall Cristal



Características / Characteristics

La luminaria Solaris LED Wall Cristal es un diseño clásico y elegante con un efecto de iluminación de cristal y diamantes de 360°, especialmente suave y cómodo, sin reflejos. Se pueden seleccionar 2 colores CCT diferentes en 1 lámpara, blanco frío o cálido elegido por usted mismo. Cuenta con 2 modos de trabajo diferentes para satisfacer diferentes aplicaciones y entornos. Además, su batería tiene una gran capacidad, protección contra sobrecarga y sobredescarga, segura y duradera y su Panel solar mono grado A con vidrio templado laminado, alta eficiencia de conversión 21%+, vida útil de 20 años, larga duración. También, el modelo Cristal está certificado IP65 a prueba de agua y polvo, adaptando el diseño para ser utilizado en amplias aplicaciones como jardines, plazas, parques, caminos, patios, recorridos, entre otros.

The Solaris LED Wall Cristal luminaire is a classic and elegant design with a particularly soft and comfortable 360° crystal and diamond lighting effect without glare. 2 different CCT colors can be selected in 1 lamp, cool or warm white chosen by yourself. It has 2 different working modes to meet different applications and environments. In addition, its battery has large capacity, overcharge and over-discharge protection, safe and durable, and its A-grade mono solar panel with laminated tempered glass, 21%+ high conversion efficiency, 20-year lifespan, long lasting. Also, the Cristal model is certified IP65 waterproof and dustproof, adapting the design to be used in wide applications such as gardens, squares, parks, paths, patios, paths, among others.

Información Técnica / Technical Information

Especificaciones / Specifications

Código SKU	Descripción Description	Potencia Power (W)	Flujo Luminoso Flux (lm)	TCC CCT (K)	Tiempo de Carga Charging Time	Tiempo de Encendido Lighting Time	Paquete de Baterías LiFePO4 Battery Pack	Panel Solar Monocristalino Mono Solar Panel	Altura de Instalación Installation Height
605015190	LUM REFLEC LED SOLARIS ILUK WALL CRISTAL 15W 1900LM	15	1900	3000K / 6000K	7H	3 Noches 3 Nights	6000mAh/3.2V/19.2Wh	5.8W/4.5V	2-3m

Dimensiones Generales (mm) / General Dimensions (mm)

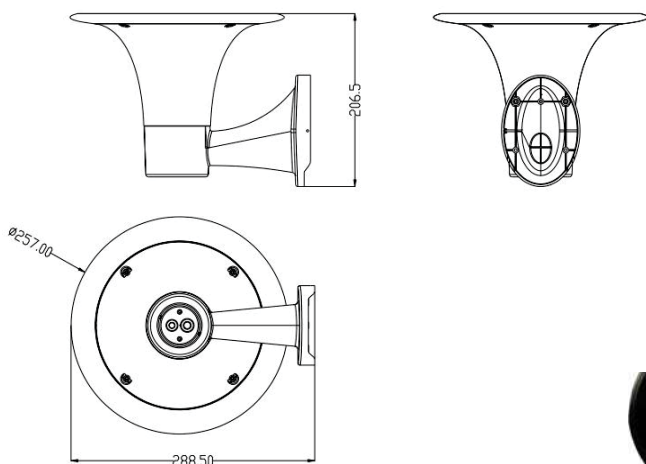

Configuraciones por botón / Optional Work Modes Button

Modo Sensor Automático / Auto Sensor Mode

La lámpara se enciende automáticamente por la noche y alcanza el brillo máximo cuando se detecta movimiento en el rango ≤ 8 Mtrs, luego cambia a un brillo más bajo en 20 segundos sin movimiento.
Lamp automatically lights up at night and turns to full brightness when motion is detected in the range ≤ 8 Mtrs, then turns to lower brightness in 20 seconds of no motion.



Modo Iluminación Mantenido / Keep Lighting Mode

La lámpara se enciende automáticamente por la noche y mantiene el 60% de brillo durante 5 horas, después de lo cual la lámpara cambia al modo de sensor automático.
Lamp automatically lights up at night and keep 60% brightness for 5 hours, after which lamp turns to Auto Sensor Mode.



Botón de cambio de Temperatura de Color / Switch Lighting CCT
Presione este botón para cambiar la temperatura del color. / Press this button to switch the color temperature.

Botón de encendido y apagado y modos de operación / ON/OFF/Switch Work Mode
1. Presione el botón por primera vez, la lámpara parpadea una vez y ingresa al modo Sensor. / Press the button 1st time, the lamp flashes once and enters the Sensor mode.
2. Presione el botón por segunda vez, la lámpara parpadea dos veces y cambia al modo Mantener Iluminación. / Press the button 2nd time, lamp flashes twice and turns to Keep Lighting Mode.
3. Presione el botón por tercera vez, la lámpara se apaga. / Press the button 3rd time, lamp turns off.





Solaris LED Wall Flat



Características / Characteristics

La luminaria Solaris LED Wall Flat es un diseño con rotación de 240°, cumpliendo con múltiples requisitos de iluminación de diferentes ambientes. Además, cuenta con temperaturas de color integradas, en conjunto con un diseño sin reflejos, iluminando muy suavemente. Contando también con una batería de gran capacidad con protección contra sobrecarga y sobredescarga, ciclos de vida 2000+, segura y duradera, reemplazable. Incorporando un control inteligente del modo de trabajo, ahorro de energía, mayor tiempo de trabajo e IP65 a prueba de agua y polvo, adaptando el diseño para ser utilizado en amplias aplicaciones como jardines, plazas, parques, caminos, patios, recorridos, entre otros.

The Solaris LED Wall Flat luminaire is a design with 240° rotation, meeting multiple lighting requirements of different environments. In addition, it has integrated color temperatures, in conjunction with a glare-free design, illuminating very softly. Also having a large capacity battery with protection against overload and over discharge, 2000+ life cycles, safe and durable, replaceable. Incorporating intelligent control of the work mode, energy saving, longer working time and IP65 waterproof and dustproof, adapting the design to be used in wide applications such as gardens, squares, parks, paths, patios, paths, among others.



Información Técnica / Technical Information

Especificaciones / Specifications

Código SKU	Descripción Description	Potencia Power (W)	Flujo Luminoso Flux (lm)	TCC CCT (K)	Tiempo de Carga Charging Time	Tiempo de Encendido Lighting Time	Paquete de Baterías LiFePO4 Battery Pack	Panel Solar Monocristalino Mono Solar Panel	Altura de Instalación Installation Height
605015200	LUM REFLEC LED SOLARIS ILUK WALL FLAT 15W 2000LM	15	2000	3000K / 6000K	7H	3 Noches 3 Nights	6000mAh/3.2V/19.2Wh	5.5W/4.5V	2-4m

Dimensiones Generales (mm) / General Dimensions (mm)

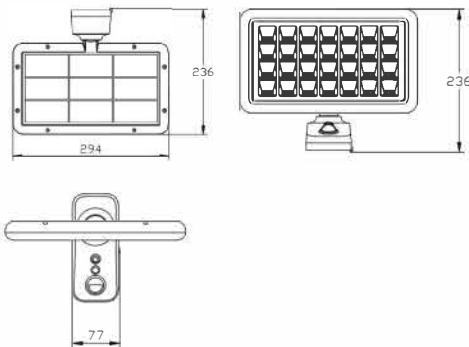

Configuraciones por botón / Optional Work Modes Button

Modo Sensor Automático / Auto Sensor Mode

La lámpara se enciende automáticamente por la noche y alcanza el brillo máximo cuando se detecta movimiento en el rango ≤ 8 Mtrs, luego cambia a un brillo más bajo en 20 segundos sin movimiento.

Lamp automatically lights up at night and turns to full brightness when motion is detected in the range ≤ 8 Mtrs, then turns to lower brightness in 20 seconds of no motion.



Modo Iluminación Mantenido / Keep Lighting Mode

La lámpara se enciende automáticamente por la noche y mantiene el 60% de brillo durante 5 horas, después de lo cual la lámpara cambia al modo de sensor automático.

Lamp automatically lights up at night and keep 60% brightness for 5 hours, after which lamp turns to Auto Sensor Mode.

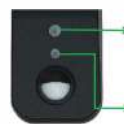

Botón de encendido y apagado y modos de operación / ON/OFF/Switch Work Mode
1. Presione el botón por primera vez, la lámpara parpadea una vez y entra al modo Sensor. / Press the button 1st time, the lamp flashes once and enters Sensor Mode.
2. Presione el botón por segunda vez, la lámpara parpadea a dos veces y cambia al modo Mantener Iluminación. / Press the button 2nd time, lamp flashes twice and turns to Keep Lighting Mode.

Botón de cambio de Temperatura de Color / Switch Lighting CCT
Presione este botón para cambiar la temperatura del color. / Press the button to switch the color temperature.



ESCUELAS
SCHOOLS



CALLES/ ESTACIONAMIENTOS
STREET/ PARKING LOTS



PARQUES
RECREATIVE AREAS



AUTOPISTAS
HIGHWAYS



HOTELES
HOTELS



AEROPUERTOS
AIRPORTS



MUSEOS/ FACHADAS
MUSEUMS/ FACADES

Solaris LED Wall Mini



7 AÑO GARANTÍA



50000 h



IP65



IK08



FOTOCELDA



-20 ~ 50°



120°

Angulo de detección
Detection Angle

6mts

Altura de detección
Height detection

CE RoHS

Características / Characteristics

La luminaria Solaris LED Wall Mini es un diseño de forma concisa y discreta, con diseño de iluminación oculta e iluminación suave, con IP65 resistente al agua, contando con una batería con protección contra sobrecarga y sobredescarga, segura y duradera e incorporando sensores PIR inteligente, trabajando a 120°/6mtrs, de sensibilidad alta y estable, en conjunto con la fotocelda del panel solar. Ideal para jardines, entradas, cercas, balcones, puertas, caminos, paredes, exteriores de edificios, entre otros.

Solaris LED Wall Mini luminaire is a concise and lowkey shape design, with concealed lighting design and soft lighting, with IP65 waterproof, with a battery with overcharge and over discharge protection, safe and durable, and incorporating intelligent PIR sensors, working at 120°/6mtrs, with high and stable sensitivity, in conjunction with the photocell of the solar panel. Ideal for gardens, entrances, fences, balconies, doors, paths, walls, building exteriors, among others.



Información Técnica / Technical Information

Especificaciones / Specifications

Código SKU	Descripción Description	Potencia Power (W)	Flujo Lumínoso Flux (lm)	TCC CCT (K)	Tiempo de Carga Charging Time	Tiempo de Encendido Lighting Time	Paquete de Baterías Li-Ion Battery Pack	Panel Solar Monocristalino Mono Solar Panel	Altura de Instalación Installation Height
605002200	LUM REFLEC LED SOLARIS ILUK WALL MINI 2W 200LM	2	220	6000K	7H	3-5 Noches 3-5 Nights	18650/3.7V/1200mA	0.7W/5.5V	2.4m

Dimensiones Generales (mm) / General Dimensions (mm)

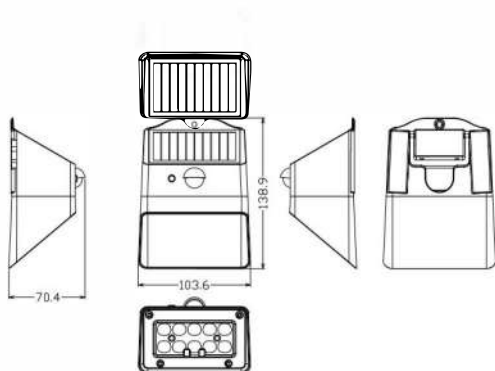

Configuraciones por botón / Optional Work Modes Botton

Modo A / Mode A

La lámpara se enciende automáticamente por la noche, cambia automáticamente al brillo máximo cuando se detecta movimiento en el rango 6 metros, luego se atenúa para reducir el brillo después de 10 segundos sin movimiento.

Lamp automatically lights up at night, automatically turns to full brightness when motion is detected in the range 6mtrs, then dims to lower brightness after 10 seconds of no motion



Modo B / Mode B

La lámpara se enciende automáticamente por la noche, cambia automáticamente a su brillo máximo cuando se detecta movimiento en el rango 6 metros y luego se apaga después de 10 segundos sin movimiento.

Lamp automatically lights up at night, automatically turns to full brightness when motion is detected in the range 6mtrs, then turns off after 10 seconds of no motion.

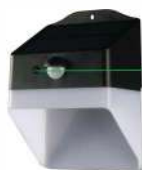
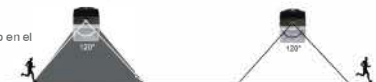

Botón de encendido y apagado y modos de operación / ON/OFF/Switch Work Mode

Presione el botón por primera vez, la lámpara se enciende y ingresa al Modo A. Presione el botón por segunda vez, la lámpara parpadea una vez y ingresa al Modo B. Presione el botón por tercera vez, la lámpara parpadea 3 veces y luego se apaga. / Press the button 1st time, lamp lights up and enters Mode A. Press the button 2nd time, lamp flashes once and enters Mode B. Press the button 3rd time, lamp flashes 3 times and then turns off.

ESCUELAS
SCHOOLSCALLES / ESTACIONAMIENTOS
STREET / PARKING LOTSPARQUES
RECREATIVE AREASAUTOPISTAS
HIGHWAYSHOTELES
HOTELSAEROPUERTOS
AIRPORTSMUSEOS / FACHADAS
MUSEUMS / FACADES



Exteriores
Outdoor

Exterior / Outdoor

Páginas / Pages: 39-44



PARKLIGHT DECO LED SCCT **39**



FLOODLIGHT SLIM LED **40**



SECURITY LED G2 **41**



WALLPACK LED MINI **42**



WALLPACK LED **43**



ILUKON BOLLARD LED **44**



Parklight Deco Led SCCT



Características / Characteristics

Luminaria para exteriores, elegante y moderna. Es resistente a la lluvia y polvo con grados de protección IP65 e IK08. Con su novedosa tecnología SCCT es posible seleccionar en ella 3 temperaturas de color (3000K/4000K/5000K) ofreciendo en una sola luminaria 3 combinaciones diferentes.

Outdoor luminaire made with rain and dust resistant materials, IP65 and IK08. Modern and elegant desing. With its innovative SCCT technology, it is possible to select 3 different color temperatures (3500K/4000K/6500K) offering a 3-in-one luminaire.



Información Técnica / Technical Information

Especificaciones / Specifications								
Código SKU	Descripción Description	Potencia Power (W)	Flujo Luminoso Flux (lm)	TCC CCT (K)	Tensión Voltage (V~)	IRC CRI	Factor de Potencia PF	Distorsión Armónica THD
60055704A	LUM PARKLIGHT DECO 3K/4K/5K 55W UL	55	6820 7700 7150	3000 4000 5000	100V-277V	>80	>0.90	<15%
60075101A	LUM PARKLIGHT DECO 3K/4K/5K 75W UL	75	9150 10350 9675					

Dimensiones Generales / General Dimensions

Formato Format	A (mm)	B (mm)	C (mm)	D (mm)
55 W/75W	455	522	380	105

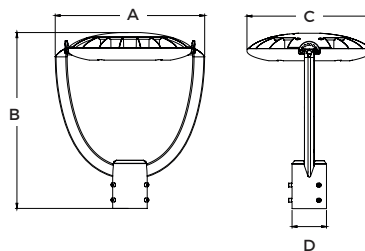

Fotometría / Photometry

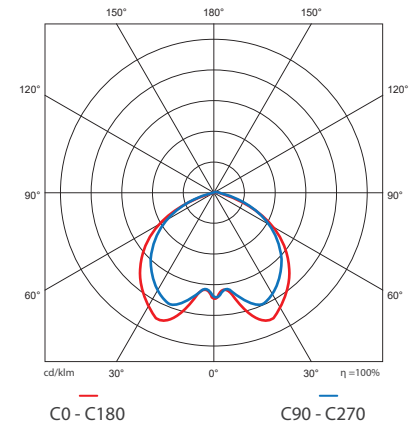



ILUKON Floodlight LED



Características / Characteristics

Luminaria de exteriores, elaborada con aluminio fundido y materiales de alta calidad. Resistente a chorros de agua, lluvia y polvo. Diseño moderno y compacto, con acabado en negro. Disponible en variedad de temperaturas de color

Outdoor luminaire with an strong housing made of die-cast aluminium and high quality materials. Resistant to waterjets, rain and dust. Modern design, black finish. Available in variety of color temperatures.



Información Técnica / Technical Information

Especificaciones / Specifications

Código SKU	Descripción Description	Potencia Power (W)	Flujo Luminoso Flux (lm)	TCC CCT (K)	Tensión Voltage (V~)	IRC CRI	Factor de Potencia PF	Ángulo de apertura Beam Angle
66750603A	LUM FLOOD LED EX PRO 12L830 100-277V 30 Khrs 10W	10	1200	3000	100 - 277V	> 80	> 0.9	110°
60675060A	LUM FLOOD LED EX PRO 12L865 100-277V 30 Khrs 10W	10	1200	6500				
60675061A	LUM FLOOD LED EX PRO 24L865 100-277V 30Khrrs 20W	20	2400	6500				
66750623A	LUM FLOOD LED EX PRO 36L830 100-277V 30Khrrs 30W	30	3600	3000				
60675062A	LUM FLOOD LED EX PRO 36L865 100-277V 30Khrrs 30W	30	3600	6500				
66750633A	LUM FLOOD LED EX PRO 60L830 100-277V 30Khrrs 50W	50	6000	3000				
60675063A	LUM FLOOD LED EX PRO 60L865 100-277V 30Khrrs 50W	50	6000	6500				
60675085A	LUM FLOOD LED EX PRO 120L865 100-277V 30Khrrs 100W	100	12000	6500				
60675086A	LUM FLOOD LED EX PRO 180L865 100-277V 30Khrrs 150W	150	18000	6500				
60675087A	LUM FLOOD LED EX PRO 240L865 100-277V 30Khrrs 200W	200	24000	6500				
60675088A	LUM FLOOD LED EX PRO 360L865 100-277V 30Khrrs 300W	300	36000	6500				
60675089A	LUM FLOOD LED EX PRO 480L865 100-277V 30Khrrs 400W	400	48000	6500				

Información de empaque / Packing information

Formato Format	CBM (Master)	Unidades por caja Units per master	Dimensiones caja (cm) Box Dimensions (cm)
10 W	0.0131	50	46.5 x 14.5 x 19.5
20 W	0.0248	50	61.5 x 16.5 x 24.5
30 W	0.0216	30	43 x 19 x 26.5
50 W	0.0249	20	42 x 35 x 17
100 W	0.0310	12	52 x 26 x 23
150 W	0.0288	10	35 x 30 x 27.5
200 W	0.0342	8	34 x 33 x 30.5
300 W	0.0449	4	45 x 27 x 37
400 W	0.0351	2	54 x 16.5 x 39.5

Dimensiones Generales / General Dimensions

Formato Format	L (mm)	W (mm)	H (mm)
10 W	82	76	25
20 W	116	103	26
30 W	134	152	26
50 W	196	160	28
100 W	240	203	31
150 W	280	240	34
200 W	310	281	35
300 W	400	322	55
400 W	500	360	62

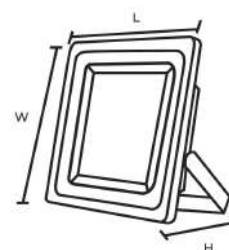

ESCUELAS SCHOOLS



CANCHAS DEPORTIVAS STADIUMS, SPORT FIELDS



PARKS RECREATIVE AREAS



MUELLES PORTS



HOTELES HOTELS



AEROPUERTOS AIRPORTS



MUSEOS/ FACHADAS MUSEUMS/ FACADES



Security Led G2



Características / Characteristics

Luminaria de exteriores, de aluminio resistente. Combina alto rendimiento, bajo mantenimiento y fácil instalación. Resistente a los rayos UV. Su diseño versátil y vanguardista la hacen ideal para aplicaciones comerciales y residenciales.

Outdoor luminaire with an strong housing made of aluminum. It is the perfect combination of high performance, low maintenance and easy installation. Its versatile and cutting-edge design makes this luminaire perfect for commercial or residential applications.



Información Técnica / Technical Information

Especificaciones / Specifications

Código SKU	Descripción Description	Potencia Power (W)	Flujo Luminoso Luminous Flux (lm)	TCC CCT (K)	Tensión Voltage (V~)	IRC CRI	Factor de Potencia PF	Distorsión Armónica THD
67035085A	LUM SECURITY LED G2 45L757 100-277V IP65 IK08 50Khrs 35W ETL	35	4550	5700	100-277 VAC	> 70	> 0.90	< 20%

Dimensiones Generales / General Dimensions

Formato Format	L (mm)	W (mm)	H (mm)
35 W	268	143	178

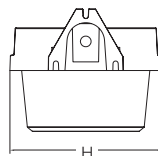
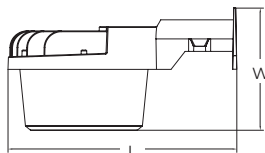

Fotometría / Photometry

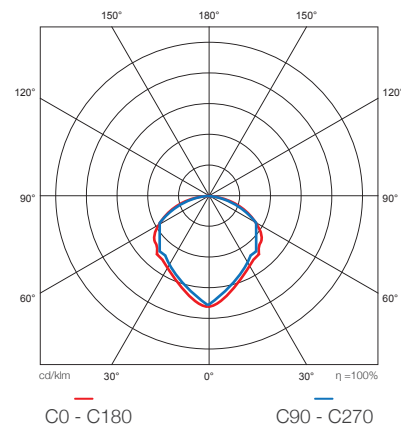



Wall Pack Led Mini



Características / Characteristics

Luminaria para sobreponer en muro, energéticamente eficiente y de larga duración. Es ideal para aplicaciones exteriores por su grado de hermeticidad IP65. Capaz de reemplazar un Wallpack de HPS de hasta 70W, ahorrando hasta un 80% de energía. Certificada UL.

Luminaire to overlap on the wall, energy efficient and long-lasting Led technology. Ideal for light up outdoor applications due to the protection degree provided by IP65. Is a powerful luminaire able to replace in up to 70W HPS wall pack as saving up to 80% in energy costs. UL listed.



Información Técnica / Technical Information

Especificaciones / Specifications								
Código SKU	Descripción Description	Potencia Power (W)	Flujo Luminoso Flux (lm)	TCC CCT (K)	Tensión Voltage (V~)	IRC CRI	Factor de Potencia PF	Distorsión Armónica THD
65743255A	LUM WALL PACK MINI 40L857 100-277V IP65 IK08 50Khrs 30W UL	30	4050	5700	100-277 VAC	> 80	> 0.90	< 20%

Dimensiones Generales / General Dimensions

Formato Format	L (mm)	W (mm)	H (mm)
30 W	218	147	78

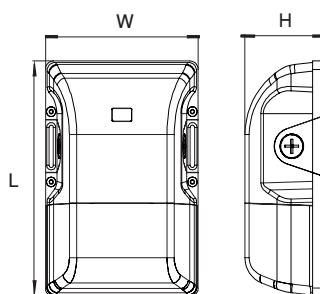

Fotometría / Photometry

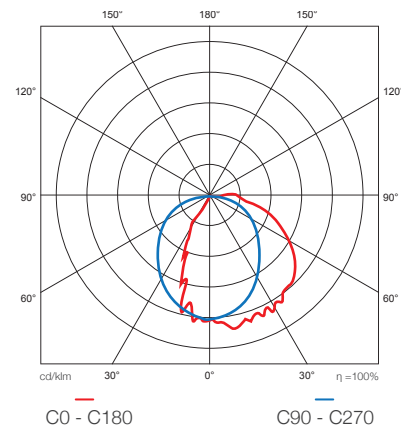

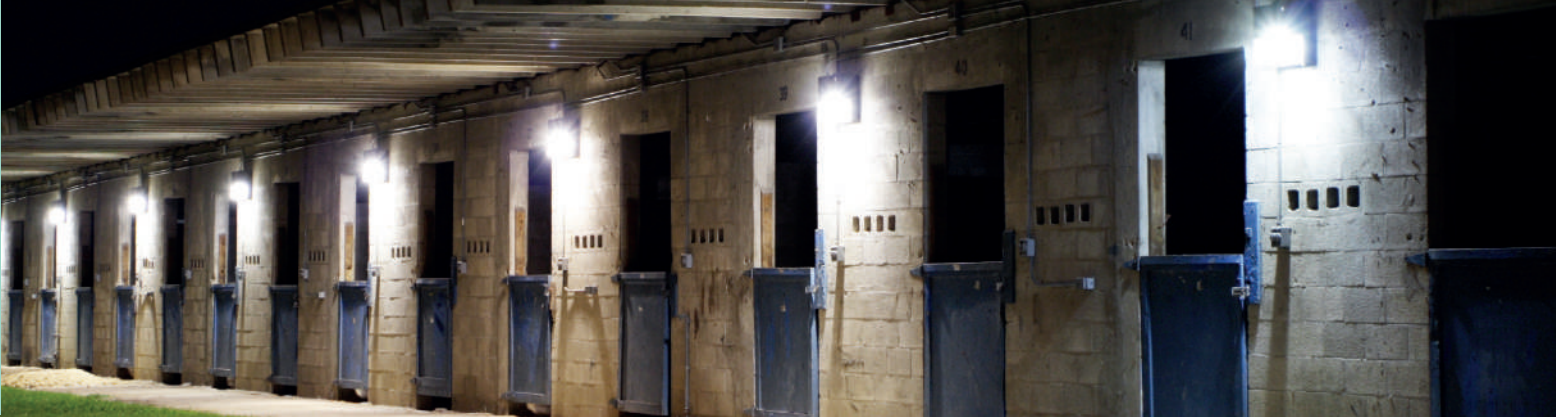

Wall Pack Led



Características / Characteristics

Luminaria para sobreponer en muro, energéticamente eficiente y de larga duración. Es ideal para aplicaciones exteriores por su grado de hermeticidad IP65 y grado IK08. Capaz de reemplazar luminarias halógenas de hasta 250W, ahorrando hasta un 86% de energía. Certificada UL.

Luminaire to overlap on the wall, energy efficient and long-lasting Led technology. Ideal for light up outdoor applications due to the protection degree provided by IP65 and IK08. Able to replace in up to 250W metal halide fixtures and saving up to 86% in energy costs. UL listed.



Información Técnica / Technical Information

Especificaciones / Specifications								
Código SKU	Descripción Description	Potencia Power (W)	Flujo Luminoso Flux (lm)	TCC CCT (K)	Tensión Voltage (V~)	IRC CRI	Factor de Potencia PF	Distorsión Armónica THD
65743285A	LUM WALL PACK 56L857 100-277V IP65 IK08 50khrs 40W UL	40	5600					
67432057A	LUM WALL PACK 56L857 100-277V IP65 IK08 50khrs 40W UL C/FOTOCELDA	40	5600	5700	100-277 VAC	> 80	> 0.90	< 20%
65743305A	LUM WALL PACK 112L857 100-277V IP65 IK08 50khrs 80W UL	80	11200					

Dimensiones Generales / General Dimensions

Formato Format	L (mm)	W (mm)	H (mm)
40W	361	252	235
80W	361	252	235

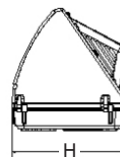
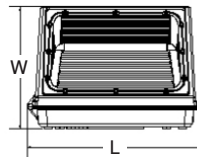

Fotometría / Photometry

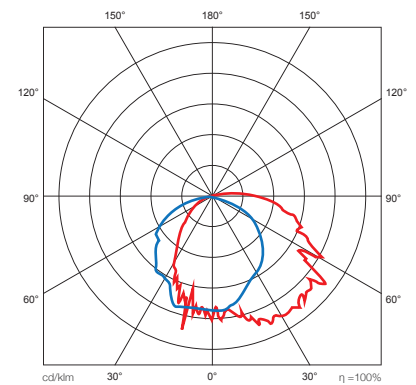



ILUKON Bollard LED

3 YEARS Warranty	30,000 Hours	Dim 0-10V	IP65	IK06	CRI >70	THD ≤20%	4kV SPD	LM79	LM80
-------------------------------	------------------------	---------------------	-------------	-------------	-------------------	--------------------	-------------------	-------------	-------------

Características / Characteristics

El bollardo LED ofrece un estilo arquitectónico con un cuerpo en aluminio extruido redondo de 6 pulgadas de una sola pieza con paredes laterales gruesas para una durabilidad extrema, una lente acrílica transparente de alto impacto y una tapa superior soldada. Las partes exteriores están protegidas por un acabado de recubrimiento en polvo termoestable súper duradero con infusión de zinc que proporciona una resistencia superior a la corrosión y la intemperie para una máxima retención de brillo y lustre que puede soportar los elementos sin agrietarse ni descascararse. Ideal para iluminar entradas de edificios, senderos y plazas peatonales, así como cualquier otro lugar que requiera una fuente de luz de baja altura.

The LED bollard offers architectural styling with a one-piece 6-inch round extruded aluminum body with thick sidewalls for extreme durability, a high-impact clear acrylic lens, and a welded top cap. Exterior parts are protected by a super durable, zinc-infused, thermosetting powder coat finish that provides superior corrosion and weather resistance for maximum gloss and luster retention that can withstand the elements without cracking or chipping. Ideal for illuminating entrances to buildings, paths and pedestrian squares, as well as any other place that requires a low light source.



Información Técnica / Technical Information

Especificaciones / Specifications							
Código SKU	Descripción Description	Potencia Power (W)	Flujo Luminoso Flux (lm)	TCC CCT (K)	Tensión Voltage (V~)	IRC CRI	Factor de Potencia PF
60891216A	LUM BOLLARDO ILUK 12W 1500LM 750 120-277V SOB IP65	12W	1500 lm	5000K	120 - 277V	> 70	> 0.60

Dimensiones Generales / General Dimensions

Formato
Format
Standar

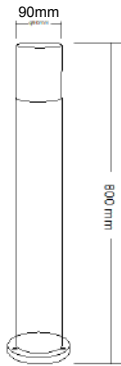



Emergencia
Emergency

Emergencia / Emergency

Páginas / Pages: 47-52



EMERGENCY DOWNLIGHT **47**



TWIN LED **48**



SQUARE LED **49**



SALIDA LED BI-COLOR **50**



SALIDA ES LED **51**



SALIDA 2H LED **52**



Emergency Downlight



Características / Characteristics

Luminaria de emergencia con retardante de flama (UL94V-0) y alta resistencia a impactos. Diseñada para montaje empotrado en cielo. Batería recargable de 120 minutos de iluminación. Con sistema de desconexión por bajo voltaje que previene que la batería se descargue completamente, incrementando la vida útil de la misma.

Emergency luminaire with flame retardant (UL94V-0) and high impact resistance. Designed for recessed ceiling mounting. Battery free of rechargeable maintenance, to guarantee minimum 120 minutes of illumination. It has a low voltage disconnection system, which prevents the battery from completely discharging, increasing its useful life.



Información Técnica / Technical Information

Especificaciones / Specifications								
Código SKU	Descripción Description	Potencia Power (W)	TCC CCT (K)	Flujo Luminoso Luminous Flux (lm)	Tensión Voltage (V~)	IRC CRI	Ángulo de Apertura Beam Angle	Batería Battery
68304170A	LUM EMERGENCY DOWNLIGHT LED 1.7L860 120MIN 100-277V 4.5W CE	3.5	6000	170	120-277 VAC	> 80	120°	3.7V NiCd

Dimensiones Generales / General Dimensions

Formato Format	L (mm)	W (mm)	H (mm)
Downlight	84	-	-
Driver	175	42	32
Batería	121	33	19

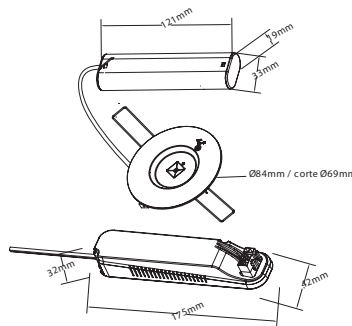

Fotometría / Photometry

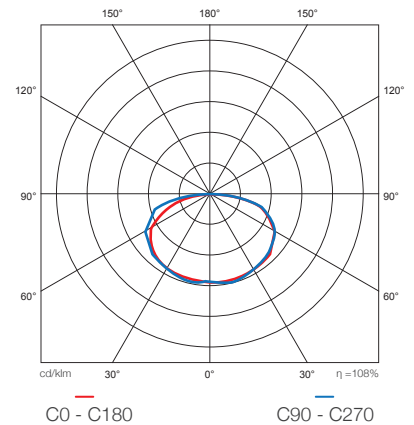



Twin LED



Características / Characteristics

Luminaria de emergencia, 100% autónoma, cuenta con interruptor de prueba, con retardante de flama y alta resistencia a impactos. Diseñada para montaje superficial, tanto en cielo como en pared. Batería recargable de 90 minutos de iluminación. Con sistema de desconexión por bajo voltaje que previene que la batería se descargue completamente, incrementando la vida útil de la misma.

Emergency luminaire, with flame retardant (5VA) and high impact resistance. Designed for surface mounting. Battery free of rechargeable maintenance, to guarantee minimum 90 minutes of illumination. It has a low voltage disconnection system, which prevents the battery from completely discharging, increasing its useful life.



Información Técnica / Technical Information

Especificaciones / Specifications

Código SKU	Descripción Description	Potencia Power (W)	Flujo Luminoso Luminous Flux (lm)	Tensión Voltage (V~)	IRC CRI	Focos Lamps	Batería Battery
67350150A	LUM TWIN LED EF-2H 2L 90MIN 120-277V 2.4W UL	2.4	200	120-277 VAC	> 80	2	3.6V NiCd

Dimensiones Generales / General Dimensions

Formato Format	L (mm)	W (mm)	H (mm)
1.2 W	300	130	60

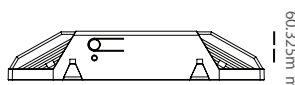
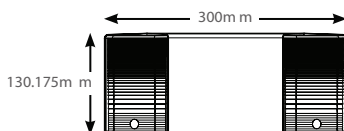

Fotometría / Photometry

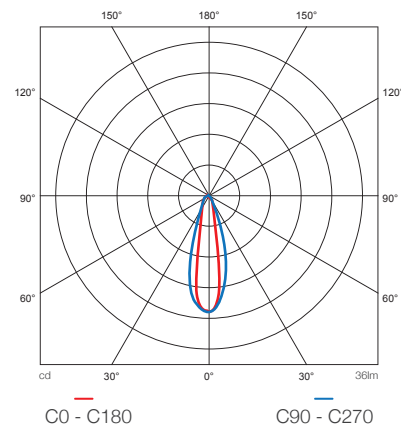



Square LED



Características / Characteristics

Luminaria de emergencia con cabezales orientables. Cuenta con interruptor de prueba y lámparas de 5.4W con lentes libres. Con retardante de flama y alta resistencia a impactos. Diseñada para montaje superficial. Batería recargable de 90 minutos de iluminación. Con sistema de desconexión por bajo voltaje que previene que la batería se descargue completamente, incrementando la vida útil de la misma.

Emergency luminaire with adjustable heads. Has a test switch and 5.4W lamps with free lenses, flame retardant and high impact resistance. Designed for surface mounting. Battery free of rechargeable maintenance, to guarantee minimum 90 minutes of illumination. It has a low voltage disconnection system, which prevents the battery from completely discharging, increasing its useful life.



Información Técnica / Technical Information

Especificaciones / Specifications							
Código SKU	Descripción Description	Potencia Power (W)	Flujo Luminoso Luminous Flux (lm)	Tensión Voltage (V~)	IRC CRI	Focos Lamps	Batería Battery
67340150A	LUM SQUARE LED EF-2H 1.8L 90MIN 120-277V 2W UL	2	185	120-277 VAC	> 80	2	3.6V NiCd

Dimensiones Generales / General Dimensions

Formato Format	L (mm)	W (mm)	H (mm)
1.2 W	371	95	95

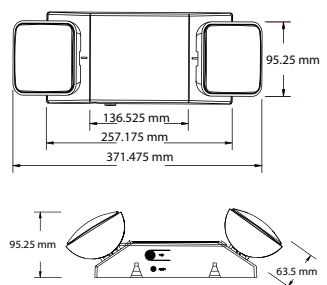

Fotometría / Photometry

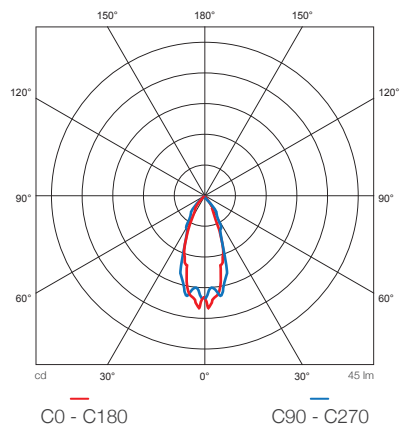

- ESCUELAS
SCHOOLS
- BODEGAS/TALLERES
WAREHOUSES/GARAGES
- COMERCIOS
COMMERCES
- OFICINAS
OFFICES
- AEROPUERTOS
AIRPORTS
- MUSEOS/ FACHADAS
MUSEUMS/FACADES
- HOSPITALES
HOSPITALS
- SUPERMERCADOS
SUPERMARKETS



Salida LED Bi-Color



Características / Characteristics

Luminaria de emergencia con led de alto brillo. Con retardante de flama y alta resistencia a impactos, cuenta con símbolos de dirección. Batería recargable de 90 minutos de iluminación. Rótulo de salida Bi-Color permite cambiar el color del lente entre verde y rojo. Carátulas de salida intercambiables.

Emergency luminaire has led sources of high brightness. With resistance to the flame and high impact resistance, have direction symbols. Battery free of rechargeable maintenance, to guarantee minimum 90 minutes of illumination. Exit sign Bi-Color available to switch the lens color between green and red. Interchangeable salida plates.



Información Técnica / Technical Information

Especificaciones / Specifications

Código SKU	Descripción Description	Tensión Tension (V~)	Color Color	Caras Face	Batería Battery
67002900A	ROTULO SALIDA LED BI-COLOR 90MIN 120-277V UL	120-277 VAC	Verde / Green Rojo / Red	2	1.2V NiMh

Dimensiones Generales / General Dimensions

Formato Format	A (mm)	B (mm)	C (mm)
Rectangular	295	183	18

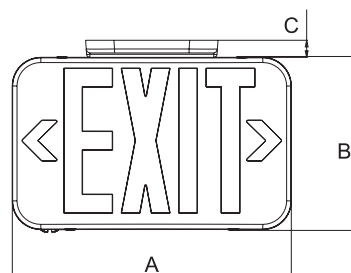



Salida ES LED



Características / Characteristics

Luminaria de emergencia con led de alto brillo, eficiencia energética y larga vida útil. Con retardante de flama y alta resistencia a impactos. Cara transparente con alternativas para montaje adosado en cielo o pared. Batería recargable de 90 minutos de iluminación.

Emergency luminaire has led sources of high brightness, energy efficiency and long life. With resistance to the flame and high impact resistance. Its transparent face it has alternatives for mounting attached to the ceiling or wall. Battery free of rechargeable maintenance, to guarantee minimum 90 minutes of illumination.



Información Técnica / Technical Information

Especificaciones / Specifications					
Código SKU	Descripción Description	Tensión Tensión (V~)	Color Color	Caras Face	Batería Battery
67300158A	ROTULO SALIDA ES LED 1 G W 90MIN 110-220V CE	110-220 VAC	Verde / Green	1	3.6V NiCd

Dimensiones Generales / General Dimensions

Formato Format	L (mm)	W (mm)	H (mm)
Rectangular	330	283	45

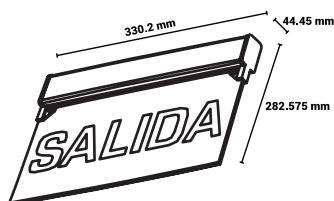



Salida 2H LED



Características / Characteristics

Luminaria de emergencia con dos lámparas ajustables de 1.2W. Con retardante de flama y alta resistencia a impactos. Con símbolos indicadores de dirección. Batería recargable de 90 minutos de iluminación.

Emergency luminaire has two adjustable lamps of 1.2W. With resistance to the flame and high impact resistance. With direction indicator symbols. Battery free of rechargeable maintenance, to guarantee minimum 90 minutes of illumination.



Información Técnica / Technical Information

Especificaciones / Specifications

Código SKU	Descripción Description	Tensión Voltage (V~)	Color Color	Focos Lamps	Batería Battery
67360862A	ROTULO SALIDA 2H LED 2 R W 90MIN 120-277V UL	120-277 VAC	Rojo / Red	2	9.6V NiCd

Dimensiones Generales / General Dimensions

Formato Format	L (mm)	W (mm)	H (mm)
Rectangular	584	279	70

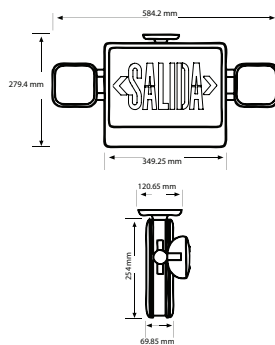



Industrial
Industrial

Industrial / Industrial

Páginas / Pages: 55-69



HIGH BAY TLXS

55



HIGH BAY SATURN

56



HIGH BAY TITAN ECHO

57



WP ACQUA LED UL

58



WP LED ECO

59



WP LED SM IP67

60



WP LED GD IP67

61



WP SM IP67 LED T8

62



WP GD IP67 T8

63



WP ECHO TUBO LED

64



STRIP FLAT LED T8

65



CINTA LED ROLLO

66



PERFIL ALUMINIO ILUKON

67



LUVER LED

68



LINEAR LINE ECHO LED

69



High Bay TLXS



Características / Characteristics

Luminaria profesional certificada UL, ideal para utilizarse en techos altos que requieren alta intensidad de luz. Esta luminaria de alto rendimiento es la opción para reemplazar sistemas fluorescentes o HID. Compatible con sensores de movimiento de microondas y PIR. Adecuada para montaje en suspensión con juego de cadenas.

Professional luminaire, certified UL, ideal for areas with high ceilings that require high intensity of light. This high performance luminaire is the perfect solution to fluorescent or HID systems retrofit. Compatible with PIR and Microwave Motion Sensors. Suited for suspension mounting with chain set.



Información Técnica / Technical Information

Especificaciones / Specifications										
Código SKU	Descripción Description	Potencia Power (W)	TCC CCT (K)	Flujo Luminoso Flux (lm)	Tensión Voltage (V~)	Formato Format	IRC CRI	Factor de Potencia PF	Distorsión Armónica THD	
66110500A	LUM HIGH BAY TLXS LED 2' 850 DL 110W UL	110		15180		2'				
66165500A	LUM HIGH BAY TLXS LED 2' 850 DL 165W UL	165	5000	22770	120V-277V	2'	>80	>0.90	>20%	
66225500A	LUM HIGH BAY TLXS LED 2' 850 DL 255W UL	255		35190		2'				
66742200A	LUM HIGH BAY TLXS LED 4' 850 DL 142 LM/W UL	300/360/400		42600/51120/56800		4'				

Dimensiones Generales / General Dimensions

Formato Format	A (mm)	B (mm)	C (mm)
110W	609	284	40
165W	609	284	40
255W	609	344	40

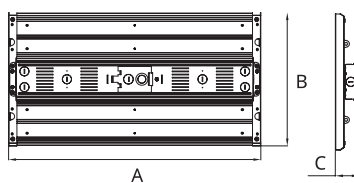

Fotometría / Photometry

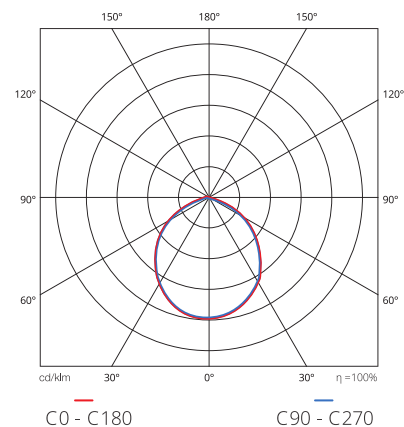



High Bay Saturn



Características / Characteristics

Luminaria profesional certificada UL, ideal para utilizarse en techos altos que requieren alta intensidad de luz. Esta luminaria de alto rendimiento es la opción para reemplazar sistemas fluorescentes o HID. Compatible con sensores de movimiento de microondas y PIR. Reflector de aluminio, refractor de PC opcionales.

Professional luminaire, certified UL, ideal for areas with high ceilings that require high intensity of light. This high performance luminaire is the perfect solution to fluorescent or HID systems retrofit. Compatible with PIR and Microwave Motion Sensors. Aluminum reflector, PC refractor available.



Información Técnica / Technical Information

Especificaciones / Specifications									
Código SKU	Descripción Description	Potencia Power (W)	TCC CCT (K)	Flujo Luminoso Luminous Flux (lm)	Tensión Voltage (V~)	Eficacia Efficacy (lm/W)	IRC CRI	Factor de Potencia PF	Distorsión Armónica THD
67742005A	LUM Highbay Saturn LED 170L857 120-277V 130Khrs 100W UL	100		17000					
67742015A	LUM Highbay Saturn LED 250L857 120-277V 130Khrs 150W UL	150	5700	25500	120-277 VAC	170	> 80	> 0.9	< 20%
67742025A	LUM Highbay Saturn LED 340L857 120-277V 130Khrs 200W UL	200		34000					

Dimensiones Generales / General Dimensions

Formato Format	AØ (mm)	B (mm)
100 W	285	103
150 W	285	103
200 W	325	106

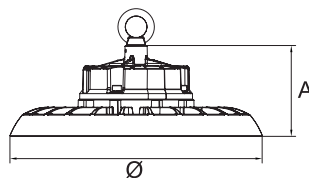

Fotometría / Photometry

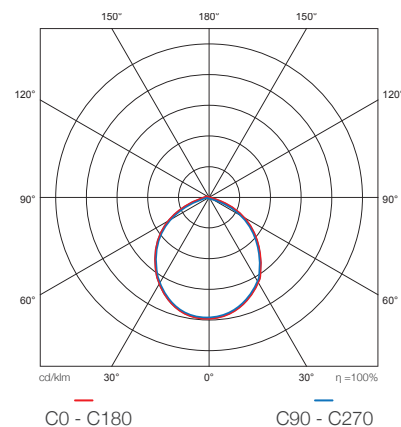



High Bay Titan Echo



Características / Characteristics

Luminaria LED de aplicación industrial, ideal para sustituir tecnologías HID y fluorescente. Con cuerpo de aluminio para la correcta disipación de calor, chips LED de alta eficiencia, hasta 120lm/W.

LED luminaire for industrial application, ideal for replacing HID and fluorescent technologies. With aluminum body for proper heat dissipation, high efficiency LED chips, up to 120lm/W.



Información Técnica / Technical Information

Especificaciones / Specifications									
Código SKU	Descripción Description	Potencia Power (W)	TCC CCT (K)	Flujo Luminoso Luminous Flux (lm)	Tensión Voltage (V~)	Eficacia Efficacy (lm/W)	IRC CRI	Factor de Potencia PF	Distorsión Armónica THD
60674287A	LUM Highbay Titan Echo LED 120L865 100-277V 30Khrs 100W	100		12000					
60674288A	LUM Highbay Titan Echo LED 180L865 100-277V 30Khrs 150W	150	6500	18000	100-277 VAC	120	> 80	> 0.9	< 20%
60674289A	LUM Highbay Titan Echo LED 240L865 100-277V 30Khrs 200W	200		24000					

Dimensiones Generales / General Dimensions

Formato Format	A Ø (mm)	B (mm)	C (mm)
100 W	254	38.3	72.2
150 W	300	39.6	72.2
200 W	330	41.8	72.2

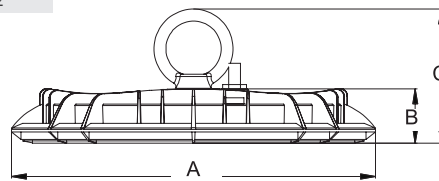

Fotometría / Photometry

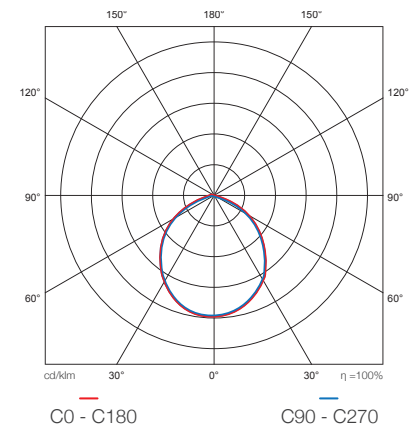

WP ACQUA LED UL

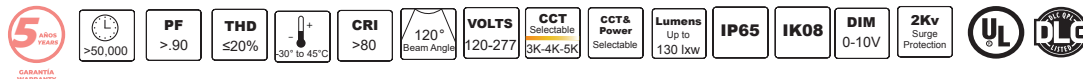

Características / Characteristics

Luminaria profesional LED industrial IP brinda una excelente iluminación y viene de serie con las certificaciones requeridas para entornos de servicio difíciles, con una construcción robusta y duradera, certificada IP65 que garantiza la integridad en lugares húmedos y mojados. Además, el modelo tiene la característica de poder seleccionar la temperatura de color y la potencia de la misma para poder ajustar su uso en el proyecto con un mayor nivel de detalle, lo cual es ideal para garajes de estacionamiento, comercio exterior, transporte público, almacenamiento en frío, áreas de servicio de alimentos o almacenes.



IP industrial LED professional luminaire provides excellent lighting and comes standard with the certifications required for harsh service environments, with a robust and durable construction, IP65 certified that guarantees integrity in damp and wet locations.

Besides. The model has the characteristic of being able to select the color temperature and its power to be able to adjust its use in the project with a greater level of detail, which is ideal for parking garages, foreign trade, public transport, storage in refrigeration, food service areas or warehouses.

Información Técnica / Technical Information

Especificaciones / Specifications

Código SKU	Descripción Description	Potencia Power (W)	TCC CCT (K)	Flujo Luminoso Flux (lm)	Tensión Voltage (V~)	Formato Format	IRC CRI	Factor de Potencia PF	Distorsión Armónica THD
62586413A	LUM WP LED ILUK 24" 25W 130LM/W 3/4/5K UL 120-277V	25w		3250		24"			
62586415A	LUM WP ACQUA LED 48" 62L, 3K,4K,5K MV DIM 0-10V IP65 30/40/50W UL	30w/40w/50w	3K/4K/5K	3900/5200/6500	120-277 VAC	48"	> 80	> 0.90	≤ 20%
61586415A	LUM WP LED ILUK 48" 30/40/50W 130LM/W 3/4/5K BE UL 120-277V	30w/40w/50w		3900/5200/6500		48"			

Notas / Notes:

Tolerancia de potencia y Flujo Luminoso $\pm 10\%$ / Power and Luminous Flux tolerance $\pm 10\%$
 Protección contra Picos = L-N:2K / Surge Protection = L-N:2K
 Soportes para montaje superficial incluidos / Surface installation kit included

Dimensiones Generales / General Dimensions

Formato Format	A (mm)	B (mm)	C (mm)
24"	580	88	83
48"	1190	88	83

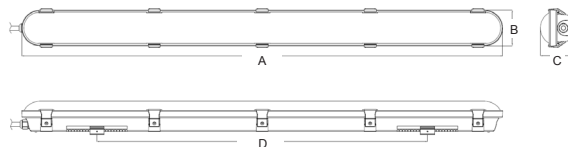

FÁBRICAS INDUSTRIES



LIBRERÍAS BOOK STORES



BODEGAS/TALLERES WAREHOUSES/GARAGES



ESCUELAS SCHOOLS



AEROPUERTOS AIRPORTS



ESTACIONAMIENTOS PARKING LOT



WP LED ECO



Sobrepuesta
Embed



Colgante
Pendant



Características / Characteristics

Luminaria industrial para montaje en superficie o colgante. Tiene clasificación IP65 que garantiza integridad en lugares húmedos y mojados. Es ideal para uso de parqueos, exteriores, cuartos fríos y bodegas.

Industrial luminaire for surface or pending mounting. Built with an IP65 grade that ensures integrity in damp and wet locations. It is ideal for parking lots, outdoors, cold rooms and warehouses.



Información Técnica / Technical Information

Especificaciones / Specifications								
Código SKU	Descripción Description	Potencia Power (W)	TCC CCT (K)	Flujo Luminoso Luminous Flux (lm)	Tensión Voltage (V~)	IRC CRI	Factor de Potencia PF	Distorsión Armónica THD
68586375A	LUM WP LED ECO 48" 865 IP65 IK06 40W CE	40	6500	4800	100-277 VAC	> 80	> 0.90	< 20%

Dimensiones Generales / General Dimensions

Formato Format	L (mm)	W (mm)	H (mm)
48"	1200	76	66

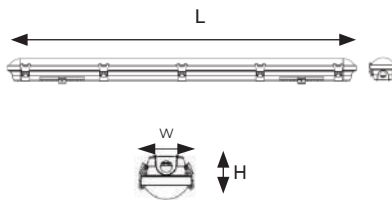

Fotometría / Photometry

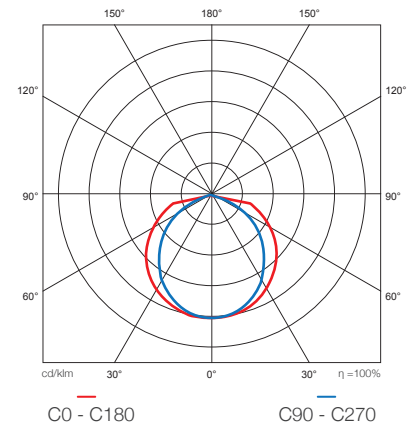

- FÁBRICAS INDUSTRIES
- LIBRERÍAS BOOK STORES
- BODEGAS/TALLERES WAREHOUSES/GARAGES
- ESCUELAS SCHOOLS
- AEROPUERTOS AIRPORTS
- ESTACIONAMIENTOS PARKING LOT

WP LED SM IP67



Características / Characteristics

Luminaria de aplicación industrial diseñada con clasificación IP67 que garantiza integridad en lugares húmedos y mojados. Su sistema de color es definida por el sistema de 3 elipses de McAdam. Driver programable Osram con funciones de:

- Flujos luminosos programables
- Porcentaje mínimo de atenuado
- Mantenimiento del flujo luminoso constante
- Indicador visual sobre el cumplimiento de la vida útil
- Integración de sensores de movimiento sin necesidad de Power Rack
- Gestión de temperatura de las barras.

Luminaire to embed it is designed for use in suspended ceiling or gypsum. Modern and functional design, provides homogeneous light of high efficiency. Its color temperature is defined by the 3-ellipse of McAdam system. Osram programmable driver with functions: • Programmable light flows • Minimum dimmable percentage • Maintenance of constant flux • Sensors of movement integration • Bars temperature management



Información Técnica / Technical Information

Especificaciones / Specifications

Código SKU	Descripción Description	Potencia Power (W)	TCC CCT (K)	Flujo Luminoso Flux (lm)	Tensión Voltage (V~)	Formato Format	IRC CRI	Factor de Potencia PF	Distorsión Armónica THD
62424250S	LUM WP LED 24" 25L840-DF MV 50Khrs IP67 20W	20		2500		24"			
62424450S	LUM WP LED 24" 45L840-DF MV 50Khrs IP67 33W	30		4500					
62488500S	LUM WP LED 48" 50L840-DF MV 50Khrs IP67 38W	38		5000					
62448650S	LUM WP LED 48" 65L840-DF MV 50Khrs IP67 45W	45		6500		48"			
62488501S	LUM WP LED 48" 85L840-DF MV 50Khrs IP67 62W	62	4000	8500	120-277 VAC		> 80	> 0.90	< 20%
62448100S	LUM WP LED 48" 100L840-DF MV 50Khrs IP67 76W	76		10000					
62496900S	LUM WP LED 96" 90L840-DF MV 50Khrs IP67 67W	67		9000					
62496150S	LUM WP LED 96" 150L840-DF MV 50Khrs IP67 114W	114		15000		96"			
62496170S	LUM WP LED 96" 170L840-DF MV 50Khrs IP67 127W	127		17000					

- Disponible con driver de emergencia / Available with emergency driver
- Disponible con tecnología DALI / Available with DALI technology
- Disponible contra pedido en TCC de 2 700K a 6 500K / Custom CCT 2 700K to 6 500K available upon request
- Disponible con difusor escarchado (DF) / Available with frosted diffuser (DF)
- Para otras configuraciones consultar con su asesor comercial / Custom set up available upon request

Dimensiones Generales / General Dimensions

Formato Format	L (mm)	W (mm)	H (mm)
24"	704	173	112
48"	1313	173	112
96"	2528	173	112

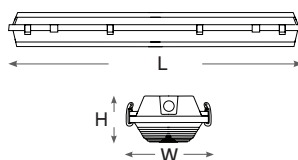

Fotometría / Photometry

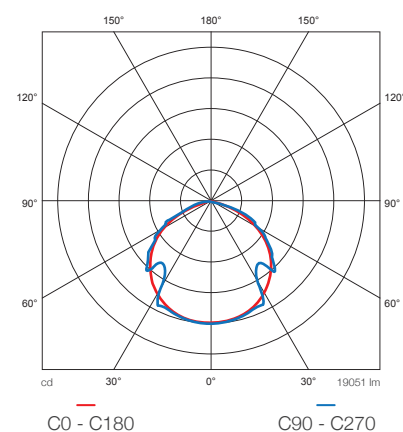



WP LED GD IP67



Características / Characteristics

Luminaria de uso superficial o suspendida mediante cable de acero o cadena (no incluidos), de aplicación industrial. Driver programable Osram con funciones de: • Flujos luminosos programables • Porcentaje mínimo de atenuado • Mantenimiento del flujo luminoso constante • Indicador visual sobre el cumplimiento de la vida útil • Integración de sensores de movimiento sin necesidad de Power Rack • Gestión de temperatura de las barras.



Luminaire to surface or suspended by steel cable or chain (not included). For industrial use. Osram high quality Led bars. Osram programmable driver with functions: • Programmable light flows • Minimum dimmable percentage • Maintenance of constant flux • Sensors of movement integration • Bars temperature management

Información Técnica / Technical Information

Especificaciones / Specifications									
Código SKU	Descripción Description	Potencia Power (W)	TCC CCT (K)	Flujo Luminoso Flux (lm)	Tensión Voltage (V~)	Formato Format	IRC CRI	Factor de Potencia PF	Distorsión Armónica THD
62488502S	LUM WP LED 48" 190L840-CL MV 50Khrs IP67 146W	146	4000	19000	120-277 VAC	48"	> 80	> 0.90	< 20%
62448220S	LUM WP LED 48" 220L840-CL MV 50Khrs IP67 150W	150		22000					
62488503S	LUM WP LED 48" 270L840-CL MV 50Khrs IP67 200W	200		27000					
62448300S	LUM WP LED 48" 300L840-CL MV 50Khrs IP67 229W	229		30000					

- Disponible con driver de emergencia / Available with emergency driver
- Disponible con tecnología DALI / Available with DALI technology
- Disponible contra pedido en TCC de 2 700K a 6 500K / Custom CCT 2 700K to 6 500K available upon request
- Disponible con difusor escarchado (DF) / Available with frosted diffuser (DF)

Fotometría / Photometry

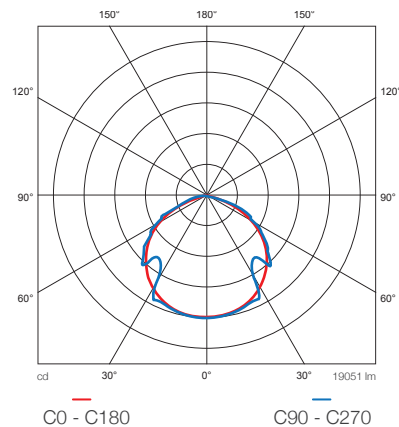

Dimensiones Generales / General Dimensions

Formato Format	L (mm)	W (mm)	H (mm)
24"	660	108	84
48"	1260	108	84

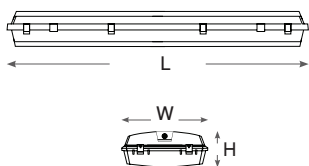

WP SM IP67 LED T8



Sobrepuesta
Embed



Colgante
Pendant



Características / Characteristics

Luminaria ideal para instalaciones de uso industrial donde hay polvo, polución o ambientes húmedos. Cuenta con grado de protección IP67. Su instalación es simple y rápida. Utiliza tubos led autobalastados de calidad Osram.

Light Fixture ideal for use in dusty, polluted or wet locations. Carries an IP67 protection degree. Easy and fast installing. Osram self-ballasted led tubes.

Información Técnica / Technical Information

Especificaciones / Specifications

Código SKU	Descripción Description	Cantidad de tubos LED tubes Qty.	Formato Format
62924267A	LUM WP ILUK 24 2T S/TUBO IP67	2	24"
62948267A	LUM WP ILUK 48 2T S/TUBO IP67	2	48"
62948367A	LUM WP ILUK 48 3T S/TUBO IP67	3	48"
62996267A	LUM WP ILUK 96 2T S/TUBO IP67	2	96"

- Para otras configuraciones consultar con su asesor comercial / Custom set up available upon request
- Disponible con driver de emergencia / Available with emergency driver
- El flujo luminoso dependerá de la cantidad y tipo de tubos led usados / Flux will depend on the amount and type of led tubes used
- TCC está dada por el tubo led usado / CCT is given by the led tube used
- Disponible con difusor acrílico transparente (CL) / Available with transparent acrylic diffuser (CL)

Dimensiones Generales / General Dimensions

Formato Format	L (mm)	W (mm)	H (mm)
24"	704	173	112
48"	1313	173	112
96"	2528	173	112

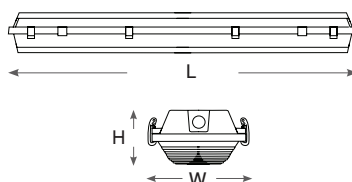

FÁBRICAS
INDUSTRIES



LIBRERÍAS
BOOK STORES



BODEGAS/TALLERES
WAREHOUSES/GARAGES



ESCUELAS
SCHOOLS



AEROPUERTOS
AIRPORTS



ESTACIONAMIENTOS
PARKING LOT



WP GD IP67 T8



Sobrepuesta
Embed



Colgante
Pendant



Características / Characteristics

Luminaria industrial ideal para uso de parqueos, exteriores, cuartos fríos y bodegas, para montaje en superficie o colgante. Tiene clasificación IP67 que garantiza integridad en lugares húmedos o con polvo. Utiliza tubos led autobalastados de calidad Osram.

Industrial luminaire ideal for parking lots, outdoors, cold rooms and warehouses, for surface or pending mounting. Built with an IP67 grade that ensures integrity in damp and wet locations. Osram self-ballasted led tubes.

Información Técnica / Technical Information

Especificaciones / Specifications									
Código SKU	Descripción Description	Cantidad de tubos LED tubes Qty.	TCC CCT (K)	Tensión Voltage (V~)	Formato Format	Ángulo de apertura Beam angle	IRC CRI	Factor de Potencia PF	Distorsión Armónica THD
629048045	LUM WP LEDT8 48 4LED K65 MV	4	6500	120-277 VAC	48"	150°	> 80	> 0.90	< 20%
629048065	LUM WP LEDT8 48 6LED K65 MV	6							

- Para otras configuraciones consultar con su asesor comercial / Custom set up available upon request
- Disponible con driver de emergencia / Available with emergency driver
- El flujo luminoso dependerá de la cantidad de tubos led usados / Flux will depend on the amount of led tubes used
- TCC está dada por el tubo Led usado / CCT is given by the Led tube used
- Disponible con difusor acrílico transparente (CL) / Available with transparent acrylic diffuser (CL)

Dimensiones Generales / General Dimensions

Formato Format	L (mm)	W (mm)	H (mm)
48"	1320	371	151

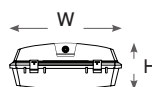

Fotometría / Photometry

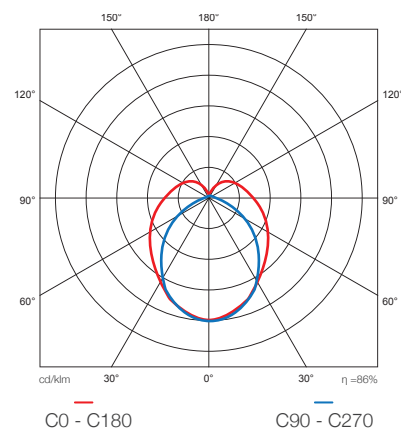

WP ECHO TUBO LED



Características / Characteristics

Luminaria hermética ideal para parqueos, talleres, bodegas
Cuerpo ABS, difusor opaco de PC
2 X 18W tubos led de vidrio de 1600 lm incluidos

Hermetic fixture ideal for parking lots, warehouses,
ABS Body, opal PC diffuser
2 X 18W glass LED tubes of 1600 lm included



Información Técnica / Technical Information

Especificaciones / Specifications

Código SKU	Descripción Description	Potencia Power (W)	TCC CCT (K)	Flujo Luminoso Luminous Flux (lm)	Tensión Voltage (V~)	Formato Format	IRC CRI	Factor de Potencia PF
62586440A	LUM WP ECHO TUBO LED IP65 48" 865	36	6500	3200	100-240	48"	>80	0.5
62586447A	LUM WP ECHO TUBO LED IP65 48" 865				100-277			

Dimensiones Generales / General Dimensions

Formato Format	A(mm)	B(mm)	C(mm)
48"	1265	96	63

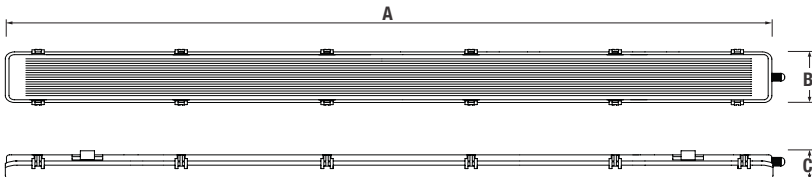

Información de empaque / Packing information

Formato Format	Unidades por caja Units per box	Caja individual Individual box (mm)	CBM CBM (K)	Peso Weight (kg)
48"	1	127 x 9.9 x 6.0	0.0075	1.2
Caja Master / Master box				
48"	12	129 x 32.5 x 21.5	0.0901	11.2



FÁBRICAS
INDUSTRIES



LIBRERÍAS
BOOK STORES



BODEGAS/TALLERES
WAREHOUSES/GARAGES



ESCUELAS
SCHOOLS



AEROPUERTOS
AIRPORTS



ESTACIONAMIENTOS
PARKING LOT



STRIP FLAT LED T8



Sobrepuesta Embed



Características / Characteristics

Luminaria de techo para aplicaciones de uso superficial. Por su diseño es ideal para escuelas, parqueos, almacenes, bibliotecas y otras aplicaciones industriales. Con tubos autobalastados calidad Osram o Ilukon. De fácil y rápida instalación.

Indoor luminaire to surface applications with a linear design. Due to its design it is ideal for lighting up schools, parking lots, stores, libraries and other industrial applications. Osram or Ilukon self-ballasted Easy and fast installing.



Información Técnica / Technical Information

Especificaciones / Specifications

Código SKU	Descripción Description	Cantidad de tubos LED tubes Qty.	TCC CCT (K)	Tensión Voltage (V~)	Formato Format	Ángulo de apertura Beam angle	IRC CRI	Factor de Potencia PF	Distorsión Armónica THD
60512050A	LUM STRIP TUBO ILUK 24 1X9W LED 765 120-240V	1	6500	120-240 VAC	24"	150°	> 70	> 0.90	< 20%
60512051A	LUM STRIP TUBO ILUK 24 2X9W LED 765 120-240V	2							
60512052A	LUM STRIP TUBO ILUK 48 1X18W LED 765 120-240V	1							
60512053A	LUM STRIP TUBO ILUK 48 2X18W LED 765 120-240V	2							
60401020A	LUM STRIP FLAT SOBREPONER PARA 1 T LED 24"	1	S / Tubos	S / Tubos	24"				
60402020A	LUM STRIP FLAT SOBREPONER PARA 2 T LED 24"	2							
60401040A	LUM STRIP FLAT SOBREPONER PARA 1 T LED 48"	1							
60402040A	LUM STRIP FLAT SOBREPONER PARA 2 T LED 48"	2							

- El flujo luminoso dependerá de la cantidad de tubos led usados / Flux will depend on the amount of led tubes used
 - TCC está dada por el tubo led usado / CCT is given by the led tube used

Dimensiones Generales / General Dimensions

Formato Format	L (mm)	W (mm)	H (mm)
24"	616	48	35
48"	1226	48	35

Fotometría / Photometry

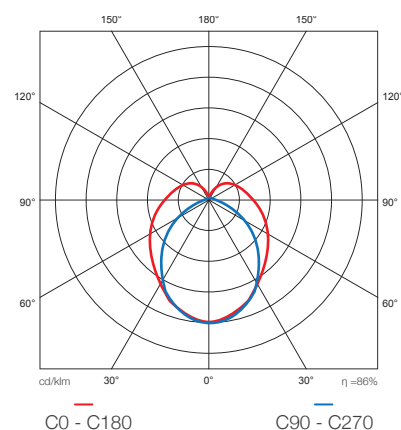

Cinta LED Rollo



Características / Characteristics

Rollo de 100 m de cinta led
Para uso en aplicaciones interiores y exteriores

Led strip 100 m reel
For use in indoor and outdoor applications



Información Técnica / Technical Information

Especificaciones / Specifications

Código Code	Descripción Description	Potencia Power (W/m)	Flujo Luminoso Luminous Flux (lm/m)	TCC CCT (K)	Tensión Voltage (V~)	IRC CRI	Factor de Potencia PF	Distancia corte Cutting distance (cm)
90576190A	Cinta led 100 m 6500K	7	600	6500	120 V	> 80	>0.9	20
90576188A	Cinta led 100 m 3000K	7	550	3000				20
90576191A	Cinta led 100 m RGB	8	-	RGB				100

Dimensiones Generales / General Dimensions

Formato Format	A (mm)	B (mm)
6500K/3000K	12	6.5
RGB	15	7

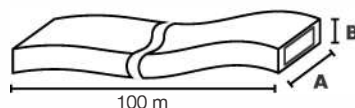

Accesorios / Accessories

	Cable de poder 6500K/3000K (90576194A)		Cable de poder RGB (90576193A)
	Unión 6500K/3000K (90576195A)		Unión RGB (90576196A)
	Tapa final 6500K/3000K (90576192A)		Tapa final RGB (90576198A)
	Clip (90576197A)		

Información de empaque / Packing information

Formato Format	Piezas por caja Pieces / master	Dimensiones de caja Box dimensions (cm)	CBM CBM	Peso bruto Gross weight (kg)
Rollo 100 m	1	32.5 x 32 x 20	0.0208	8 / 8 (RGB)

Tapa final	Cable de poder	Unión	Clip
1000 pcs / carton 50 bolsas x 20	100 pcs / carton 20 bolsas x 5	1000 pcs / carton 50 bolsas x 20	1000 / carton 10 bolsas x 100

Notas / Notes

- El cable de poder debe ser instalado en caja hermética en cumplimiento del código eléctrico vigente.
- Toda línea debe terminar con una tapa final y silicón.
- The power cord must be installed in a hermetic box in compliance with the current electrical code.
- Always end a line with an end cap and glue.



FÁBRICAS
INDUSTRIES



LIBRERÍAS
BOOK STORES



BODEGAS/TALLERES
WAREHOUSES/GARAGES



ESCUELAS
SCHOOLS



AEROPUERTOS
AIRPORTS



ILUKON
PROFESSIONAL LIGHTING

www.gls-ca.com
Tel: (506) 2203-3939
E-mail: contact@glc-ca.com



Perfil aluminio ILUKON

Características / Characteristics

Perfil de aluminio para cinta led de 1 metros de longitud. Opciones para empotrar y para sobreponer. Acabado aluminio natural. Difusor opalino.

Aluminum profile for LED strip 1 meter long. Options for recessed and surface-mounted. Natural aluminum finish. Opal diffuser.

Información Técnica / Technical Information

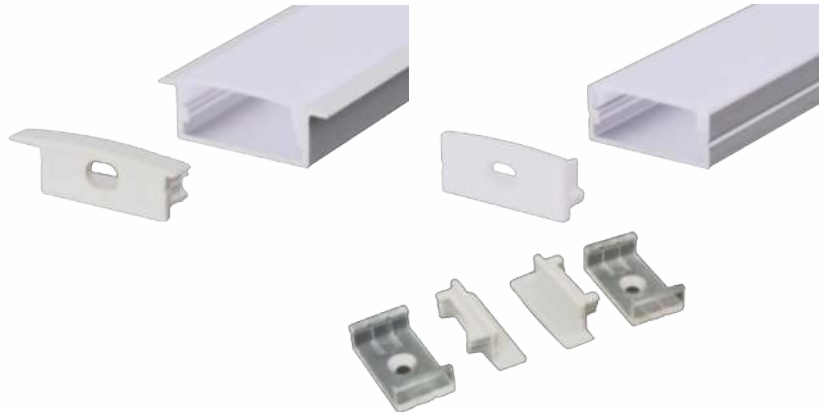

Incluye dos tapas laterales y dos prensas de soporte.

Includes two side covers and two support presses.

Dimensiones Generales / General Dimensions

Código	Modelo	A (mm)	B (mm)	C (mm)
900024010	SOB	24	10	21
900030010	EMP	30.3	9.8	21.3

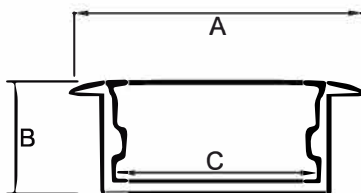
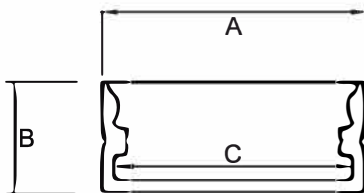

Instalación / Installation

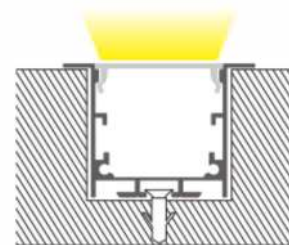
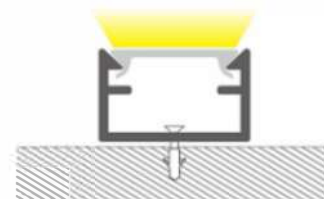

FÁBRICAS
INDUSTRIES



LIBRERÍAS
BOOK STORES



BODEGAS/TALLERES
WAREHOUSES/GARAGES



ESCUELAS
SCHOOLS



AEROPUERTOS
AIRPORTS



ESTACIONAMIENTOS
PARKING LOT



LUVER LED



Sobrepuesta
Embed



Características / Characteristics

Luminaria de techo para sobrepuesta con diseño lineal. Por su diseño es ideal para aplicaciones comerciales o residenciales, fabricada con un cuerpo fabricado en acero y extremos plásticos y una regilla protectora que cubre los tubos LED.

Light Fixture to embed with a linear design. Due to its design it is ideal for lighting up residential or commercial ambiances, made with a body made of steel and plastic ends and a protective grid that covers the LED tubes.



Información Técnica / Technical Information

Especificaciones / Specifications

Código SKU	Descripción Description	Cantidad de tubos LED tubes Qty.	TCC CCT (K)	Tensión Voltage (V~)	Formato Format	Ángulo de apertura Beam angle	IRC CRI	Factor de Potencia PF
60512061A	LUM LUVER ILUK 48 2X18W T LED 6500K 110-240V PAR	2	6500	110-240V	48"	120°	70	0.5

- Para otras configuraciones consultar con su asesor comercial /

Custom set up available upon request

Dimensiones Generales / General Dimensions

Formato Format	Largo (mm)	W (mm)	H (mm)
48"	1230	125	43

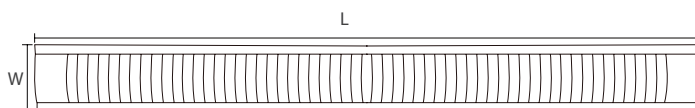



Linear Line Echo LED



Sobrepueta
Embed



Características / Characteristics

Luminaria de techo para sobreponer con diseño moderno y minimalista que combina lo más avanzado en distribución óptica. Las ópticas innovadoras ofrecen una uniformidad excepcional, con un led de alta potencia.

Surface-mounted ceiling luminaire with a modern and minimalist design that combines the most advanced in optical distribution. Innovative optics offer exceptional uniformity, with a high-power LED.



Información Técnica / Technical Information

Especificaciones / Specifications

Código SKU	Descripción Description	Potencia Power (W)	Flujo Luminoso Flux (lm)	Tensión Voltage (V~)	Formato Format	TCC CCT (K)	IRC CRI	Factor de Potencia PF	Distorsión Armónica THD
60224180A	LUM LINE ECHO LED ILUK 24 18W 765 120-240V SOB	18	1400	120-240VAC	24"	6500	> 70	> 0.50	< 20%
60248360A	LUM LINE ECHO LED ILUK 48 36W 765 120-240V SOB	36	2800		48"				

Dimensiones Generales / General Dimensions

Formato Format	L (mm)	W (mm)
24"	600	75
48"	1200	75

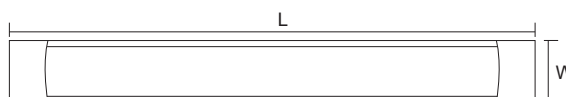

FÁBRICAS
INDUSTRIES



LIBRERÍAS
BOOK STORES



BODEGAS/TALLERES
WAREHOUSES/GARAGES



ESCUELAS
SCHOOLS



AEROPUERTOS
AIRPORTS



ESTACIONAMIENTOS
PARKING LOT



Profesional
Professional



Profesional / Professional

Páginas / Pages: 73-82



PANEL BACKLIGHT SCCT

73



PANEL BACKLIGHT

74



PANEL CLEANROM

75



TROFFER LED PRO G2 UL

76



TROFFER LED

77



TROFFER LED T8

78



LINEAR LED SCCT PRO

79



DOWNLIGHT DLX PRO+ UL

80



ILUKON CLD

81



LINEAR MEDICAL

82



Panel Backlight SCCT

5
AÑOS
PELLE
GARANÍA
WARRANTY

50000h

0-10V

**Dimm
SCCT**

**9-en-1
SCCT**

**9-en-1
SCCT**

**Cielo Suspendido
Suspended Ceiling**

**Sobrepueta
Embed**

Características / Characteristics

Luminaria de techo de sobreponer tipo panel, ideal para la iluminación de oficinas y ambientes corporativos. Con su novedosa tecnología SCCT es posible seleccionar en ella misma 3 temperaturas de color (4000K/5000K/6500K) y 3 potencias, ofreciendo en una sola luminaria 9 combinaciones diferentes.

Sistema LED de larga duración (PCB LED), controlador electrónico UL, y con protección contra sobretensiones de 1KV. Puede ser instalada en cielo suspendido o colgante (accesorios no incluidos)



Panel type ceiling luminaire to embed. It is ideal to light up offices and corporate ambiances. With its innovative SCCT Technology, it is possible to select 3 different color temperatures (from 4000K to 6500K) and a wattage selectable 30W/ 40W/ 50W, offering a 9-in-one luminaire. Long-life LED system (LED PCB) coupled with UL electronic driver, with 1KV surge protection, to deliver optimal performance. Can be instaled on suspended or pendant ceilings (accessories not included).



Información Técnica / Technical Information

Especificaciones / Specifications									
Código SKU	Descripción Description	Potencia Power (W)	TCC CCT (K)	Flujo Luminoso Luminous Flux (lm)	Tensión Voltage (V~)	Formato Format	IRC CRI	Factor de Potencia PF	Distorsión Armónica THD
90674923A	BACKLIGHT 1X4 SLM SCCT	3 en 1 3 in 1 20 30 40	4000 5000 6500	3 en 1 3 in 1 2000 3000 4000	120-277 VAC	1x4	> 80	> 0.9	< 20%
90674922A	BACKLIGHT 2X2 SLM SCCT	3 en 1 3 in 1 20 30 40	4000 5000 6500	3 en 1 3 in 1 2000 3000 4000		2x2			
90674924A	BACKLIGHT 2X4 SLM SCCT	3 en 1 3 in 1 30 40 50	4000 5000 6500	3 en 1 3 in 1 3000 4000 5000		2x4			

Dimensiones Generales / General Dimensions

Formato Format	L (mm)	W (mm)	H (mm)
1x4	1213	303	62
2x2	603	603	62
2x4	1213	603	62

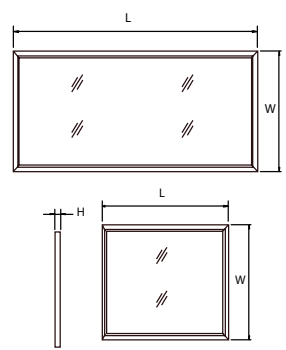

Fotometría / Photometry

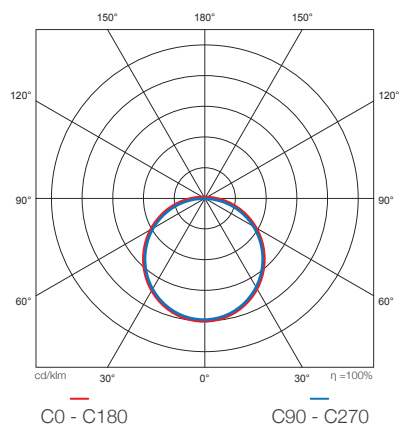

Panel Backlight



Cielo Suspendido
Suspended Ceiling

Sobrepuesta
Embed

Características / Characteristics

Luminaria de techo de sobreponer tipo panel, ideal para iluminación de proyectos que requieren maximizar la eficiencia energética y luminosa. Es perfecta tanto para nuevos proyectos así como retrofit. Con kits opcionales, esta luminaria puede ser instalada en cielos de superficie y suspendidos.

Su diseño moderno ayuda a distribuir la luz de manera homogénea, con su lente blanca escarchada.

Panel type ceiling luminaire to embed. It is ideal to light up projects that requires maximize electrical luminous efficiency. These luminaire is perfect for both new construction or retrofit projects. The Panel Backlight may also installed surface or suspended mounted using the optional kits. Modern design. White frost lens provides uniform illumination.



Información Técnica / Technical Information

Especificaciones / Specifications

Código SKU	Descripción Description	Potencia Power (W)	Flujo Luminoso Luminous Flux (lm)	TCC CCT (K)	Tensión Voltage (V~)	Formato Format	IRC CRI	Factor de Potencia PF	Distorsión Armónica THD
90501042A	LUM PANEL LED BACKLIGHT 1X4 38L865 100-277V 25Khrs 40W CE	40	3800	6500	100-277 VAC	1x4	> 80	> 0.9	< 20%
90503840A	LUM PANEL LED BACKLIGHT 2X2 40L840 100-277V 25Khrs 40W CE	40	4000	4000		2x2			
90504032A	LUM PANEL LED BACKLIGHT 2X2 40L865 100-277V 25Khrs 40W CE	40	4000	6500		2x2			
90506052A	LUM PANEL LED BACKLIGHT 2X4 60L865 100-277V 25Khrs 60W CE	60	6000	6500		2x4			

Dimensiones Generales / General Dimensions

Formato Format	L (mm)	W (mm)	H (mm)
1X4	1213	303	30
2x2	603	603	30
2x4	1213	603	30

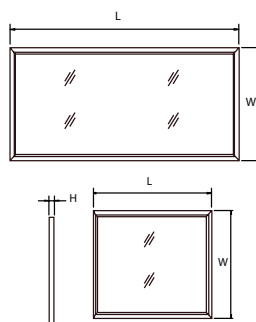

Fotometría / Photometry

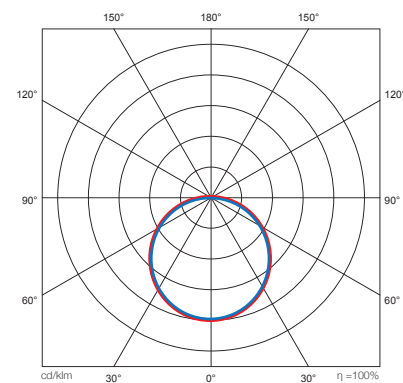



Panel Cleanroom HealthLight

Cielo Suspendido / Suspended Ceiling
 Sobrepuesta / Embed

Características / Characteristics

Luminaria ideal para ambientes hospitalarios, laboratorios, procesamiento de alimentos, industria farmacéutica entre otros. Cuenta con protección IP54 y apta para ambientes húmedos. Tecnología LED de alta luminosidad y difusor opaco para óptima distribución luminosa. Otras configuraciones disponibles: 3000K, 5000K, 6500K y batería de emergencia.

Ideal luminaire for hospital environments, laboratories, food processing, pharmaceutical industry, among others. IP54 rating protection and suitable for damp locations. High brightness LED technology and opaque diffuser for optimal light distribution. Other configurations available: 3000K, 5000K, 6500K and emergency pack.



Información Técnica / Technical Information

Especificaciones / Specifications									
Código SKU	Descripción Description	Potencia Power (W)	TCC CCT (K)	Flujo Luminoso Luminous Flux (lm)	Tensión Voltage (V~)	Formato Format	IRC CRI	Factor de Potencia PF	Distorsión Armónica THD
90674934A	LUM PANEL LED CLEANROOM 1X4 50L840 120-277V 70Khrs 40W UL	40		5000		1x4			
90674930A	LUM PANEL LED CLEANROOM 2X2 50L840 120-277V 70Khrs 40W UL	40	4000	5000	120-277 VAC	2x2	> 80	> 0.9	< 20%
90674938A	LUM PANEL LED CLEANROOM 2X4 62L840 120-277V 70Khrs 50W UL	50		6250		2x4			

Dimensiones Generales / General Dimensions

Formato / Format	L (mm)	W (mm)	H (mm)
1x4	1213	303	39
2x2	603	603	39
2x4	1213	603	39

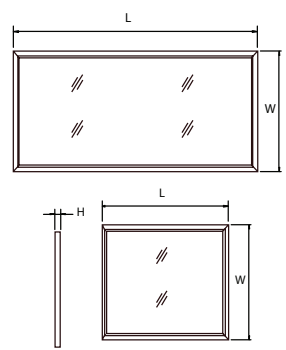

Fotometría / Photometry

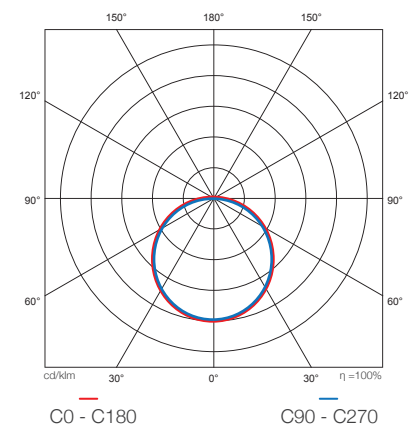

Troffer LED PRO G2 UL



Cielo Suspendido
Suspended Ceiling



Características / Characteristics

Luminaria de techo para cielo suspendido o gypsum. Su diseño moderno ofrece rendimiento y ahorro energético. Con su novedosa tecnología SCCT es posible seleccionar en ella misma 3 temperaturas de color (4000K/5000K/6000K) y 3 potencias, ofreciendo en una sola luminaria 9 combinaciones diferentes.

Su panel central genera luz uniforme y confort visual. Driver independiente de fácil acceso. El difusor de alto rendimiento permite que no se vean los LEDs sin afectar el flujo luminoso.

Luminaire to embed it is designed for use in suspended ceiling or gypsum. Modern design, provides an outstanding performance and energy savings. With its innovative SCCT Technology, it is possible to select 3 different color temperatures (from 4000K to 6000K) and a wattage selectable 30W/ 40W/ 50W, offering a 9-in-one Luminarie. With its central panel, it generates uniform light and visual confort. Independent and easy to access driver. The high-performance diffuser allows the Led not to be seen without affecting the luminous flux.



Información Técnica / Technical Information

Especificaciones / Specifications

Código SKU	Descripción Description	Potencia Power (W)	TCC CCT (K)	Flujo Luminoso Luminous Flux (lm)	Tensión Voltage (V~)	Formato Format	IRC CRI	Factor de Potencia PF	Distorsión Armónica THD
61240225A	TROFFER LED PRO G2 T 2X2 SLM 8CCT SW UL	3 en 1 3 in 1 30 35 40	4000 5000 6000	3 en 1 3 in 1 3750 4375 5000	100-277 VAC	2x2	> 80	> 0.9	< 20%
61240245A	TROFFER LED PRO G2 T 2X4 SLM 8CCT SW UL	3 en 1 3 in 1 30 40 50	4000 5000 6000	3 en 1 3 in 1 3750 5000 6250		2x4			

Accesorios / Accessories

Código / Sku	Descripción / Description
90570022A	KIT DE SOBREPONER LUM TROFFER LED PRO G2 2X2
90570024A	KIT DE SOBREPONER LUM TROFFER LED PRO G2 2X4

Dimensiones Generales / General Dimensions

Formato Format	L (mm)	W (mm)	H (mm)
2x2	603	603	66
2x4	1212	603	66

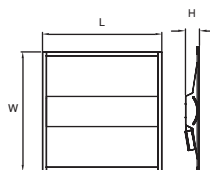

Fotometría / Photometry

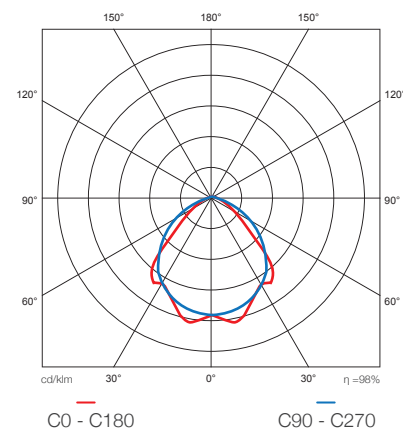



Troffer LED



Características / Characteristics

Luminaria de techo para cielo suspendido o gypsum. Ideal para iluminación de oficinas y ambientes corporativos. Con marco abatible para su fácil mantenimiento y limpieza. Provisto con sistema de desconexión de línea individual y barras led calidad Osram. Driver programable Osram con funciones de:

- Flujos luminosos programables
- Porcentaje mínimo de atenuado
- Mantenimiento del flujo luminoso constante
- Integración de sensores de movimiento
- Gestión de temperatura de las barras.



Luminaire to embed it is designed for use in suspended ceiling or gypsum. It is ideal to light up offices and corporate ambiances. It uses a folding frame for easy maintenance and cleaning. Equipped with an individual line disconnection system. Osram high quality led bars. Osram programmable driver with functions:

- Programmable light flows
- Minimum dimmable percentage
- Maintenance of constant flux
- Sensors of movement integration
- Bars temperature management

Información Técnica / Technical Information

Especificaciones / Specifications

Código SKU	Descripción Description	Potencia Power (W)	Difusor * Diffuser *	Flujo Luminoso Luminous Flux (lm)	Tensión Voltage (V~)	Formato Format	IRC CRI	Factor de Potencia PF	Distorsión Armónica THD
62148501T	LUM TROFFER LED T 1x4 PRGL840 1 120-277V 50Khrs	Programable con el driver	1	Programable con el driver	120-277 VAC	1x4	> 80	> 0.9	< 20%
62148502T	LUM TROFFER LED T 1x4 PRGL840 4LD 120-277V 50Khrs		4LD						
62228500T	LUM TROFFER LED T 2x2 PRGL840 1 120-277V 50Khrs	Programable with driver	1	Programable with driver		2x2			
62228501T	LUM TROFFER LED T 2x2 PRGL840 4LD 120-277V 50Khrs		4LD						
62248500T	LUM TROFFER LED T 2x4 PRGL840 1 120-277V 50Khrs	1	4LD	2x4					
62248501T	LUM TROFFER LED T 2x4 PRGL840 4LD 120-277V 50Khrs								

- Disponible con driver de emergencia / *Emergency driver available*
- Disponible con tecnología DALI/ *DALI technology available*
- (*) Disponible con difusor de acrílico prismático o acrílico lechoso / *Available with prismatic acrylic diffuser*

Flujos Luminosos Flux Chart

lm	W
2500	20
3000	21
4000	29
4500	33
5000	37
5500	38
5900	41
6000	41
6500	45
7000	53
8000	58
8500	62
9000	67
9500	71
10000	76
11000	78

Dimensiones Generales / General Dimensions

Formato Format	L (mm)	W (mm)	H (mm)
1x4	1218	298	96
2x2	603	603	96
2x4	1218	603	96

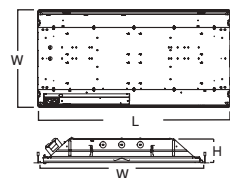

Fotometría / Photometry

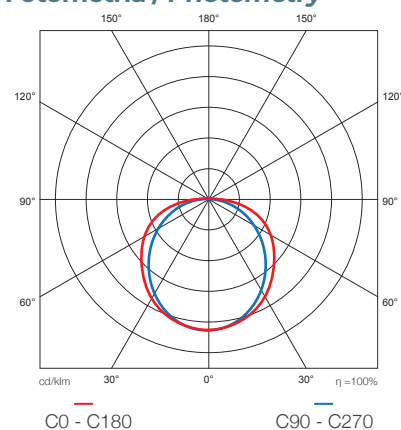

Troffer LED T8



Cielo Suspending
Suspended Ceiling

Características / Characteristics

Luminaria de techo para cielo suspendido o gypsum. Ideal para iluminación de oficinas y ambientes corporativos. Con marco abatible para su fácil mantenimiento y limpieza. Tubos led autobalastados de calidad Osram o Ilukon.



Luminaire to embed it is designed for use in suspended ceiling or gypsum. It is ideal to light up offices and corporate ambiances. It uses a folding frame for easy maintenance and cleaning. Osram or Ilukon self-ballasted led tubes.

Información Técnica / Technical Information

Especificaciones / Specifications

Código SKU	Descripción Description	Cantidad de tubos LED tubes Qty.	Dimensiones Dimensions	Difusor Diffuser
6014020GU	LUM TROFFER ILUK 1X4 2T S/TUBO LED EMP CS D/PRISM	2	1x4	Acrílico prismático / Acrylic prismatic
60514201A	LUM TROFFER ILUK 1X4 2T S/TUBO LED EMP CS D/P5	2		Acrílico P5 / P5 Acrylic
60514202A	LUM TROFFER ILUK 1X4 2T S/TUBO LED EMP CS D/ACRI	2		Acrílico opalino / Acrylic opaline
6022033GU	LUM TROFFER ILUK 2x2 3T S/TUBO LED EMP CS D/PRISM	3	2x2	Acrílico prismático / Acrylic prismatic
60522301A	LUM TROFFER ILUK 2x2 3T S/TUBO LED EMP CS D/P5	3		Acrílico P5 / P5 Acrylic
60522302A	LUM TROFFER ILUK 2x2 3T S/TUBO LED EMP CS D/ACRI	3		Acrílico opalino / Acrylic opaline
6022040GU	LUM TROFFER ILUK 2x2 4T S/TUBO LED EMP CS D/PRISM	4	2x2	Acrílico prismático / Acrylic prismatic
60522401A	LUM TROFFER ILUK 2x2 4T S/TUBO LED EMP CS D/P5	4		Acrílico P5 / P5 Acrylic
60522402A	LUM TROFFER ILUK 2x2 4T S/TUBO LED EMP CS D/ACRI	4		Acrílico opalino / Acrylic opaline
62030240T	LUM TROFFER ILUK 2X4 3T S/TUBO LED EMP CS D/PRIS	3	2x4	Acrílico prismático / Acrylic prismatic
61224030T	LUM TROFFER ILUK 2X4 3T S/TUBO LED EMP CS D/P5	3		Acrílico P5 / P5 Acrylic
60524301A	LUM TROFFER ILUK 2X4 3T S/TUBO LED EMP CS D/ACRI	3		Acrílico opalino / Acrylic opaline
6122250GU	LUM TROFFER ILUK 2X4 4T S/TUBO LED EMP CS D/PRIS	4		Acrílico prismático / Acrylic prismatic
60524401A	LUM TROFFER ILUK 2X4 4T S/TUBO LED EMP CS D/P5	4		Acrílico P5 / P5 Acrylic
60524402A	LUM TROFFER ILUK 2X4 4T S/TUBO LED EMP CS D/ACRI	4		Acrílico opalino / Acrylic opaline

Notas

- Disponible con driver de emergencia / Emergency driver available
- El flujo luminoso y las características eléctricas dependerán de la cantidad y tipo de tubos led a usar / The luminous flux and the electrical characteristics were based on the quantity and type of LED tubes to be used.
- TCC está dada por el tubo led usado / CCT is given by the led tube used

Dimensiones Generales / General Dimensions

Formato Format	L (mm)	W (mm)	H (mm)
1x4	1218	298	96
2x2	603	603	96
2x4	1218	603	96

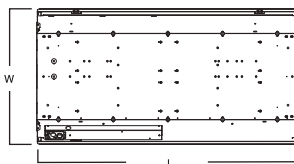

Linear LED SCCT PRO



Características / Characteristics

Luminaria lineal colgante modular apta para oficinas, salas de reuniones, recepciones. Sus 4 interruptores permiten variar la potencia, TCC directa, TCC indirecta y distribución de luz directa/indirecta. Variedad de accesorios para ampliar sus aplicaciones. Cuerpo de aluminio con acabado blanco, difusor de policarbonato.

Pendant indoModular hanging linear luminaire suitable for offices, meeting rooms, receptions. Its 4 switches allow you to vary the power, direct TCC, indirect TCC and direct/indirect light distribution. Variety of accessories to expand your applications. Aluminum body with white finish, polycarbonate diffuser.

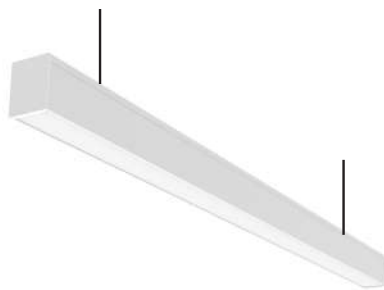

Distribución luminosa / Light distribution (%)					
Indirecta / UP	100	70	50	30	0
Directa / Down	0	30	50	70	100

Información Técnica / Technical Information

Especificaciones Técnica / Technical Specifications

Código / Code	Descripción / Description	Potencia / Power (W)	Flujo Luminoso / Flux (lm)	Tensión / Voltage (Vac)	Formato / Format	TCC CCT (K)	IRC CRI	Factor de potencia / FP	DATI THDi (%)
60586453A	LUM LINEAR SCCT PRO 24" D/I	25	3500	120-277	24"	3000/3500/4000 5000/5700	>80	>0.9	<20
		20	2800						
		15	2100						
		10	1400						
60448350A	LUM LINEAR SCCT PRO 48" D/I	50	7000	120-277	48"	3000/3500/4000 5000/5700	>80	>0.9	<20
		45	6300						
		40	5600						
		35	4900						
60586456A	LUM LINEAR SCCT PRO 96" D/I	100	14000	120-277	96"	3000/3500/4000 5000/5700	>80	>0.9	<20
		90	12600						
		75	10500						
		60	8400						

- Notas:
- Cable de poder 1 m hasta máximo 600W (24"=24 pcs / 48"=12 pcs / 96"=6 pcs)
 - Incluye 4 pcs de expansión para montaje superficial

Accesorios / Accessories

- Kit suspensión (1.2 m)
- Kit para empotrar sin marco
- Sensor microondas
- Batería de emergencia
- Marco empotrar 24"
- Marco empotrar 48"
- Marco empotrar 96"
- Accesorio pared 24"
- Accesorio pared 48"
- Accesorio pared 96"

Dimensiones Generales / General Dimensions

Formato / Format	A (mm)	B (mm)	C (mm)
24"	600	55.8	69.85
48"	1200	55.8	69.85
96"	2400	55.8	69.85



Información de empaque / Packing information

Modelo / Model	CBM (Master)	Unidades por caja / Units per box	Dimensiones por caja / Box dimensions (cm)	Peso / Weight (kg)
24"	0.0150	4	62 x 14.2 x 16.8	6.1
48"	0.0290	4	122 x 14.2 x 16.8	9.6
96"	0.0570	4	241 x 14.2 x 16.8	15.2

Conectores / Connectors

Conector L 90° (25-40W) Conector L 120° (25-40W) Conector T (45-60W) Conector X (65-80W)

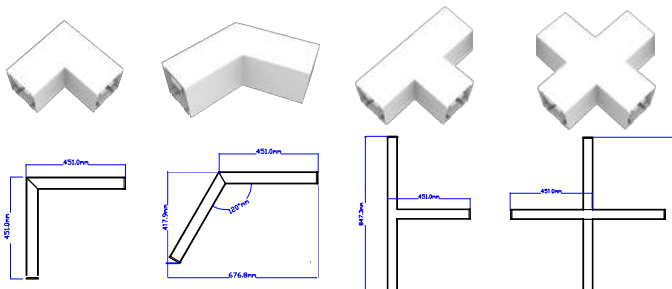



Downlight DLX PRO+ UL



Empotrable
Recessed



Características / Characteristics

Downlight DLX Pro+ es una luminaria de empotrar que permite cambiar su temperatura de color entre 5 opciones: 2700K-3000K-3500K-4000K-5000K y su potencia entre 3 opciones por medio de selectores manuales, que además permite atenuación mediante el protocolo 0-10V.

The Downlight DLX Pro+ Series with selectable CCT & power are specification grade recessed downlights ideal for ceiling plenum applications. Quality, housing-free recessed downlighting is achieved with its fully enclosed modular system ensuring maximum heat dissipation. Secure trim retention with two side-mounted spring clips for easy installation.



Información Técnica / Technical Information

Especificaciones / Specifications										
Código SKU	Descripción Description	Potencia Power (W)	Flujo Luminoso Flux (lm)	TCC CCT (K)	Dimensiones Dimensions	Tensión Voltage (V~)	Ángulo de apertura Beam Angle	IRC CRI	Factor de Potencia PF	Distorsión Armónica THD
68582561A	LUM DOWNLIGHT DLX PRO+ 4" SWL9SCCT 100-277V 0-10V 50Khrs 7/10/13W UL	3 en 1 7	3 en 1 650	2700K	4"	100-277 VAC	90°	> 90	> 0.98	< 20%
		3 in 1 10	3 in 1 930							
		3 in 1 13	3 in 1 1060							
68582562A	LUM DOWNLIGHT DLX PRO+ 6" SWL9SCCT 100-277V 0-10V 50Khrs 10/15/22W UL	3 en 1 10	3 en 1 890	3000K	6"	100-277 VAC	90°	> 90	> 0.98	< 20%
		3 in 1 15	3 in 1 1285							
		3 in 1 22	3 in 1 1970							
68582563A	LUM DOWNLIGHT DLX PRO+ 8" SWL9SCCT 100-277V 0-10V 50Khrs 12/20/30W UL	3 en 1 12	3 en 1 1120	3500K	8"	100-277 VAC	90°	> 90	> 0.98	< 20%
		3 in 1 20	3 in 1 1820							
		3 in 1 30	3 in 1 2520							
68582564A	LUM DOWNLIGHT DLX PRO+ 10" SWL9SCCT 100-277V 0-10V 50Khrs 20/30/40W UL	3 en 1 20	3 en 1 1820	4000K	10"	100-277 VAC	90°	> 90	> 0.98	< 20%
		3 in 1 30	3 in 1 2420							
		3 in 1 40	3 in 1 3120							

Dimensiones Generales / General Dimensions

Formato Format	ØA (mm)	ØB (mm)	C (mm)
7/10/13W	95	136	77
10/15/22W	150	209	101
12/20/30W	186	260	112
20/30/40W	218	287	126

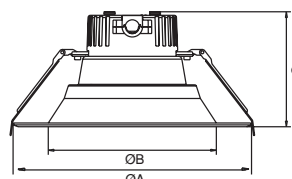

Fotometría / Photometry

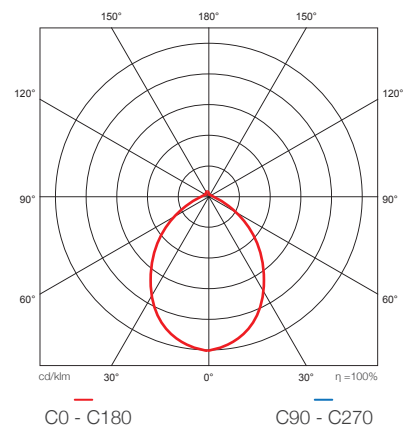



ILUKON CLD



Características / Characteristics

Luminaria UL circular tipo cilindro con LED integrado para colgar y sobreponer. Opciones de ángulo, temperatura de color y potencia seleccionables en un solo producto. Diseño minimalista.

Información Técnica / Technical Information

Especificaciones Técnica / Technical Specifications										
Código Code	Descripción Description	Potencia Power (W)	Flujo Luminoso Flux (lm)	Tensión Voltage (Vac)	Ángulo de salida Beam Angle (°)	TCC CCT (K)	IRC CRI	Factor de potencia FP	DATI THDi (%)	
XXXXXX	LUM CLD SCCT BK	21/28/35	1596/2128/2660	120-277	30/40/50/60	3000K/4000K/5000K/6000K	>80	>0.9	<20	
XXXXXX	LUM CLD SCCT WH									

Accesorios / Accessories

- Kit suspensión blanco (2.4 m)
- Kit suspensión negro (2.4 m)

Dimensiones Generales / General Dimensions

Formato Format	A (mm)	B (mm)
48"	146	183

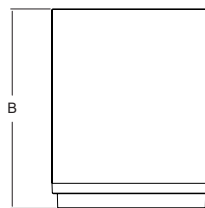
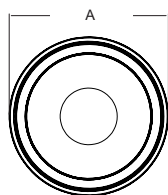

Información de empaque / Packing information

Modelo Model	CBM (Master)	Unidades por caja Units per box	Dimensiones por caja Box dimensions (cm)	Peso Weight (kg)
21/28/35W	0.0322	6	48 x 32 x 21	10





Linear Medical



Sobrepuesta
Embed



Características / Characteristics

Luminaria lineal sobrepuesta de uso hospitalario.
Iluminación hacia arriba y hacia abajo con interruptor independiente.
Con variedad de opciones.
Cuerpo de aluminio y difusor de policarbonato.

*Lineal surface luminaire to use in hospitals.
Up and Down light with independent switch.
Several options.
Aluminum body and polycarbonate diffuser.*



Información Técnica / Technical Information

Especificaciones / Specifications

Código Code	Descripción Description	TCC CCT (K)	Potencia Power (W)	Flujo Luminoso Flux (lm)	Tensión Voltage (V~)	Formato Format	IRC CRI	Factor de Potencia PF	Distorsión Armónica THD
680210020	LINEAR LED MEDICAL 20W	5000	10W + 10W	1050 + 1050	120V - 277V	2'	>80	> 0.95	> 15%
680220040	LINEAR LED MEDICAL 40W		20W + 20W	2100 + 2100		4'			

Dimensiones Generales / General Dimensions

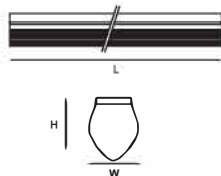

Formato Format	L (mm)	W (mm)	H (mm)
2'	590	91	133
4'	1198	91	133

Opciones / Options

Atenuación 0-10V	0-10V dimming
Kit emergencia	Emergency pack
Interruptor de cadena	Pull chain switch
Tomacorriente	Outlet socket
Puerto USB	USB socket





Residential
Residential

Residencial / Residential

Páginas / Pages: 85-92



SPOT ECHO

85



DOWNLIGHT SLIM RD

86

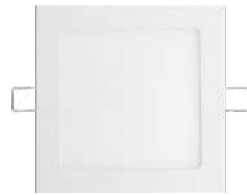

DOWNLIGHT SLIM SQ

87



DOWNLIGHT SURFACE RD

88

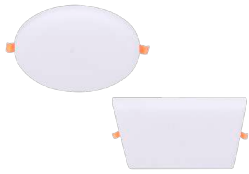

DOWNLIGHT EVO

89



TURTLE LIGHT LED

90



CINTA LED KIT

91



ILUKON FANTASY STRING LED

92

SPOT ECHO



Características

El Spot Echo es una luminaria ideal para iluminación de acento. Sustituto de halógenos. Ajustable en un ángulo de hasta 30°.



Información Técnica

Especificaciones / Specifications

Código Code	Descripción Description	Potencia Power (W)	TCC CCT (K)	Flujo Luminoso Luminous Flux (lm)	Tensión Voltage (V~)	IRC CRI	Factor de Potencia PF
60582221A	LUM LED SPOT ECHO REDONDO 7W	7	3000	560	120	80	>0.5
60582223A	LUM LED SPOT ECHO REDONDO 7W	7	6500	610			
60582240A	LUM LED SPOT ECHO REDONDO 12W	12	3000	960			
60582243A	LUM LED SPOT ECHO REDONDO 12W	12	6500	1050			
68582221A	LUM LED SPOT ECHO REDONDO 7W DIMM	7	3000	560			
68582223A	LUM LED SPOT ECHO REDONDO 7W DIMM	7	6500	610			
68582240A	LUM LED SPOT ECHO REDONDO 12W DIMM	12	3000	960			
68582243A	LUM LED SPOT ECHO REDONDO 12W DIMM	12	6500	1050			
60582215A	LUM LED SPOT ECHO CUADRADO 7W	7	3000	560			
60582217A	LUM LED SPOT ECHO CUADRADO 7W	7	6500	610			
60582232A	LUM LED SPOT ECHO CUADRADO 12W	12	3000	960			
60582235A	LUM LED SPOT ECHO CUADRADO 12W	12	6500	1050			
68582217A	LUM LED SPOT ECHO CUADRADO 7W DIMM	7	6500	610			
68582232A	LUM LED SPOT ECHO CUADRADO 12W DIMM	12	3000	960			
68582235A	LUM LED SPOT ECHO CUADRADO 12W DIMM	12	6500	1050			

Dimensiones Generales

Modelo	A (mm)	B (mm)	C (Cut out)
7 W	114	50	100
12 W	135	57	120

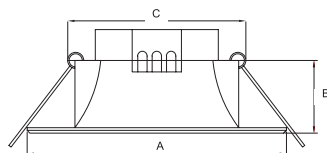

Información de empaque

Modelo	CBM (Master) RD / SQ	Unidades por caja RD / SQ	Dimensiones caja (cm) RD / SQ	Peso (kg) RD / SQ
7 W	0.0535 / 0.0635	20	61.3 x 34.1 x 25.6 / 72.8 x 34.1 x 25.6	3.17 / 3.30
12 W	0.0804 / 0.0933	20	71.3 x 38.1 x 29.6 / 82.8 x 38.1 x 29.6	4.3 / 4.61



Downlight Slim RD

IP20

3 años
GARANTÍA
WARRANTY

30000h

ULTRA
SLIM
7.11"Empotrable
Recessed

Características / Characteristics

Downlight empotrable con diseño ultradelgado redondo. Su diseño sin carcasa, es ideal para aplicaciones en cielorrasos con tan solo 2 pulgadas de espacio libre. Es sencillo y rápido de instalar.

La serie Slim Round ofrece una amplia gama de tamaños y potencias.

Indoor recessed downlight with ultra-slim round design. Its housing-free design is ideal for installation in ceilings with as little as 2 inches of clearance. It is easy and simple to install. The Slim Round Series offers a wide range of sizes and wattages.



Información Técnica / Technical Information

Especificaciones / Specifications

Código SKU	Descripción Description	Potencia Power (W)	TCC CCT (K)	Flujo Luminoso Luminous Flux (lm)	Tensión Voltage (V~)	Ángulo de Apertura Beam Angle	IRC CRI	Factor de Potencia PF	Distorsión Armónica THD
68086506A	DOWNLIGHT EMPOTRAR RND 4" 6W	6	6500	360	120-277	120°	> 80	> 0.5	< 20%
68009540A	DOWNLIGHT EMPOTRAR RND 5" 9W	9		580					
68201211A	DOWNLIGHT EMPOTRAR RND 6" 12W	12		840					
68014125A	DOWNLIGHT EMPOTRAR RND 7" 15W	15		1100					
68201811A	DOWNLIGHT EMPOTRAR RND 8" 18W	18		1400					
64216524A	DOWNLIGHT EMPOTRAR RND 11" 24W	24	3000	1800	120-277	120°	> 80	> 0.5	< 20%
68083006A	DOWNLIGHT EMPOTRAR RND 4" 6W	6		360					
68209010A	DOWNLIGHT EMPOTRAR RND 5" 9W	9		580					
68582309A	DOWNLIGHT EMPOTRAR RND 6" 12W	12		840					
68582315A	DOWNLIGHT EMPOTRAR RND 8" 18W	18		1400					

Dimensiones Generales / General Dimensions

Dimensión Nominal	A (mm)	B (mm)	C (mm)*
6W	120	6	105
9W	145	6	130
12W	170	6	155
15W	190	6	175
18W	220	6	205
24W	300	6	285

- * Medida para corte / Cut out



Fotometría / Photometry

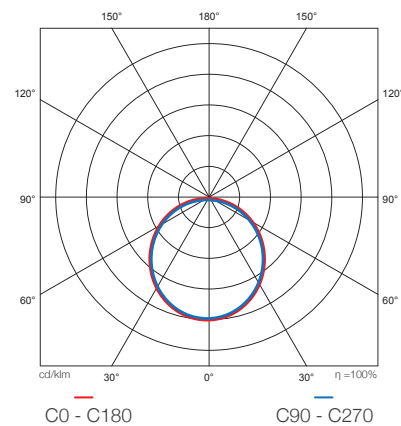
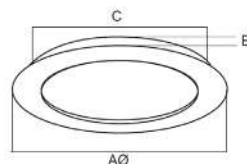

Downlight Slim SQ

IP20

3 años GARANTÍA WARRANTY

30000h

ULTRA SLIM

Empotrable Recessed



Características / Characteristics

Downlight empotrable con diseño ultradelgado cuadrado. Su diseño sin carcasa, es ideal para aplicaciones en cielorrasos con tan solo 2 pulgadas de espacio libre. Es sencillo y rápido de instalar.

La serie Slim Square ofrece una amplia gama de tamaños y potencias siendo una de las favoritas entre diseñadores y arquitectos.

Indoor recessed downlight with ultra-slim squared design. Its housing-free design is ideal for installation in ceilings with as little as 2 inches of clearance. It is easy and simple to install. The Slim Square Series offers a wide range of sizes and wattages making it a favorite among designers and architects.

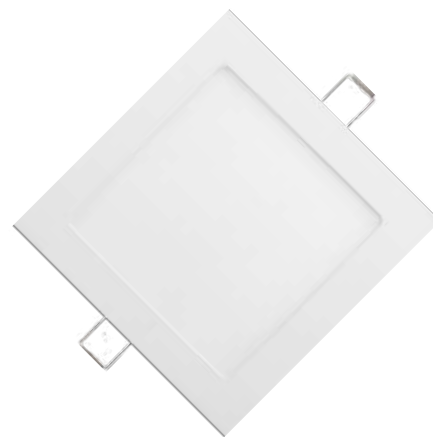

Información Técnica / Technical Information

Especificaciones / Specifications

Código SKU	Descripción Description	Potencia Power (W)	TCC CCT (K)	Flujo Luminoso Luminous Flux (lm)	Tensión Voltage (V~)	Ángulo de Apertura Beam Angle	IRC CRI	Factor de Potencia PF	Distorsión Armónica THD
68200612A	DOWNLIGHT EMPOTRAR 5"	6	6500	360	120-277	120°	> 80	> 0.5	< 20%
68201212A	DOWNLIGHT EMPOTRAR 7"	12		840					
68201812A	DOWNLIGHT EMPOTRAR 9"	18		1400					
68202412A	DOWNLIGHT EMPOTRAR 12"	24		1800					

Dimensiones Generales / General Dimensions

Dimensión Nominal	A-B (mm)	C (mm)*	D (mm)
6W	120	105	6
9W	145	130	6
12W	170	155	6
15W	190	175	6
18W	220	205	6
24W	300	280	6

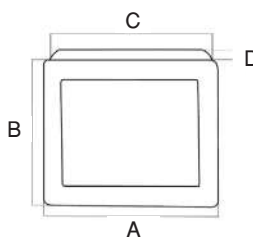

- * Medida para corte / Cut out

COMERCIOS
COMMERCESRESIDENCIAS
HOUSEHOLDSLIBRERÍAS
BOOK STORESESCUELAS
SCHOOLSOFICINAS
OFFICESTIENDAS
STORES

Fotometría / Photometry

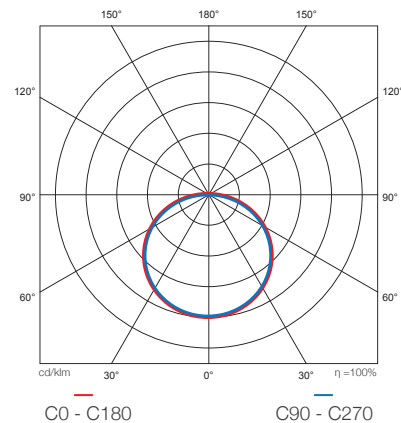



Downlight Surface RD

IP20

3 años
GARANTÍA
WARRANTY

30000h

ULTRA
SLIMSobrepuesta
Embed

Características / Characteristics

Downlight Surface es una luminaria ultra fina de techo para sobreponer, ideal para proyectos residenciales y comerciales. Equipada con led de alta potencia, ilumina el ambiente de manera uniforme. Es de fácil y rápida instalación.

Downlight Surface is an ultra-thin luminaire to embed. It is ideal to light up residential or commercial projects. Equipped with a high power led with homogeneous light distribution. Easy to install.



Información Técnica / Technical Information

Especificaciones / Specifications

Código SKU	Descripción Description	Potencia Power (W)	TCC CCT (K)	Flujo Luminoso Luminous Flux (lm)	Tensión Voltage (V~)	Ángulo de Apertura Beam Angle	IRC CRI	Factor de Potencia PF	Distorsión Armónica THD
65928656A	DOWNLIGHT LED SURFACE RD 4"	6	6500	270	120-277	120°	> 80	> 0.5	< 20%
65823390A	DOWNLIGHT LED SURFACE RD 7"		3000						
64201212A	DOWNLIGHT LED SURFACE RD 7"	12	6500	600					
65823420A	DOWNLIGHT LED SURFACE RD 9"		3000						
64201812A	DOWNLIGHT LED SURFACE RD 9"	18	6500	1080					
65823450A	DOWNLIGHT LED SURFACE RD 12"		3000						
64206524A	DOWNLIGHT LED SURFACE RD 12"	24	6500	1440					

Dimensiones Generales / General Dimensions

Dimensión Nominal	A (mm)	B (mm)
12W	155	28
18W	205	28
24W	280	28

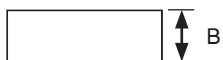
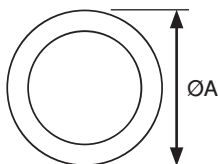

Fotometría / Photometry

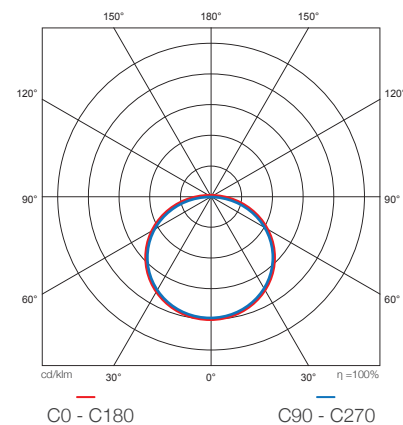
COMERCIOS
COMMERCESRESIDENCIAS
HOUSEHOLDSLIBRERÍAS
BOOK STORESESCUELAS
SCHOOLSOFICINAS
OFFICESTIENDAS
STORES



Downlight EVO LED

IP20

2
AÑOS
DE GARANTÍA

15000h

ULTRA
SLIM
7.75mmEmpotrable
RecessedSobrepuerta
Embed

CE

Características / Characteristics

Downlight empotrable o de sobreponer con diseño ultradelgado sin marcos. Su diseño sin carcasa, es ideal para aplicaciones en cielorrasos con tan solo 2 pulgadas de espacio libre. Es sencillo y rápido de instalar. La serie EVO ofrece una amplia gama de tamaños y potencias.

Indoor recessed or embed downlight with ultra-slim frameless design. Its housing-free design is ideal for installation in ceilings with as little as 2 inches of clearance. It is easy and simple to install. The Evo Series offers a wide range of sizes and wattages.

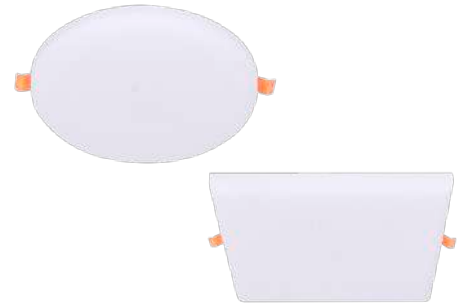

Información Técnica / Technical Information

Especificaciones / Specifications

Código SKU	Descripción Description	Potencia Power (W)	TCC CCT (K)	Flujo Luminoso Luminous Flux (lm)	Tensión Voltage (V~)	Ángulo de Apertura Beam Angle	IRC CRI	Factor de Potencia PF	Distorsión Armónica THD
68048920A	LUM DL EVO RD ILUK 9W 720LM 765 120V EMP IP20 3"	9	6500	720	120-240 VAC	120°	> 70	> 0.5	< 20%
68048180A	LUM DL EVO RD ILUK 18W 1440LM 765 120V EMP IP20 4"	18		1440					
68048240A	LUM DL EVO RD ILUK 24W 1920LM 765 120V EMP IP20 6"	24		1920					
68048921A	LUM DL EVO SQ ILUK 9W 720LM 765 120V EMP IP20 3"	9		720					
68048181A	LUM DL EVO SQ ILUK 18W 1440LM 765 120V EMP IP20 4"	18		1440					
68048241A	LUM DL EVO SQ ILUK 24W 1920LM 765 120V EMP IP20 6"	24		1920					
68048182A	LUM DL EVO RD ILUK 18W 1440LM 765 120V PAR IP20 4"	18		1440					
68048242A	LUM DL EVO RD ILUK 24W 1920LM 765 120V PAR IP20 6"	24		1920					
68048183A	LUM DL EVO SQ ILUK 18W 1440LM 765 120V PAR IP20 4"	18		1440					
68048243A	LUM DL EVO SQ ILUK 24W 1920LM 765 120V PAR IP20 6"	24		1920					

Dimensiones Generales / General Dimensions

Dimensión Nominal	A (mm)	B (mm)	C (mm)	* (mm)
9W ROUND EMP	85	21		55-70
18W ROUND EMP	120	21		55-90
24W ROUND EMP	170	21		55-135
9W SQUARE EMP	85	85	21	55-70
18W SQUARE EMP	120	120	21	55-90
24W SQUARE EMP	170	170	21	55-135
18W ROUND PAR	120	44		
24W ROUND PAR	170	44		
18W SQUARE PAR	120	120	44	
24W SQUARE PAR	170	170	44	

- * Medida para corte / Cut out

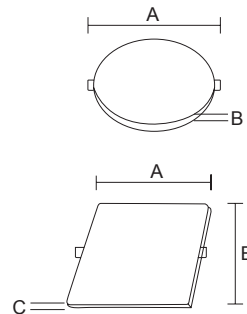
COMERCIOS
COMMERCESRESIDENCIAS
HOUSEHOLDSLIBRERÍAS
BOOK STORESESCUELAS
SCHOOLSOFICINAS
OFFICESTIENDAS
STORES

Fotometría / Photometry

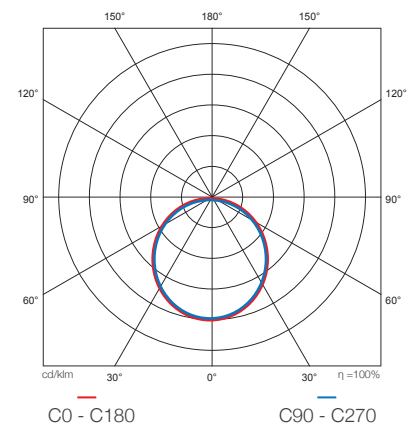



Turtle Light LED



Características / Characteristics

La serie Turtle Light LED tiene un diseño de inspiración náutica similar a las luces utilizadas en los barcos.

Tienen clasificación IP65 y grado IK08 resistente al vandalismo, lo que los hace ideales para servicio rudo y condiciones ambientales extremas.

Architectural wall-mounted luminaire, have a nautical-inspired design, evoking the lights that ships use. For indoor and outdoor, carries IP65 protection degree as well as IK08 grade that make it vandal resistant. Ideal for light up extreme environmental conditions.



Información Técnica / Technical Information

Especificaciones / Specifications									
Código SKU	Descripción Description	Potencia Power (W)	Flujo Luminoso Flux (lm)	TCC CCT (K)	Tensión Voltage (V~)	Formato Format	IRC CRI	Factor de Potencia PF	Distorsión Armónica THD
60801200A	LUM TURTLE OV 11L865 100-130V IP65 IK08 30Khrs 12W CE	12	1100	6500	100-130 VAC	Óvalo Oval	> 80	> 0.50	< 20%

Dimensiones Generales / General Dimensions

Formato Format	L (mm)	W (mm)	H (mm)
Ovalada	205	97	58

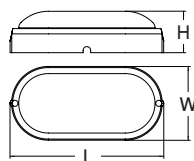

Fotometría / Photometry

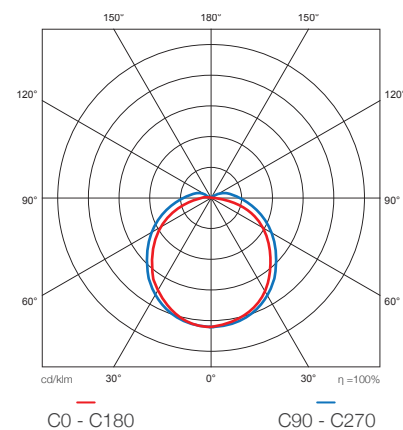

Cinta Led Kit

IP65

1
AÑO
GARANTÍA
WARRANTY

15000 h

ULTRA
SLIM
2.1mm5m
LONGITUD
LENGTHSobrepuesta
Embed

Características / Characteristics

Cinta LED Kit se ha ensamblado para que pueda configurar los LED fácilmente en poco tiempo, se pueden usar en prácticamente cualquier lugar de exterior e interior. Agregue un acento a la arquitectura de cualquier edificio para llamar la atención. Disfrute de una iluminación ultrabrillante con baja temperatura y bajo consumo de energía.

Cinta LED Kit has been put together so you can easily set up LEDs in no time, they can be used in practically any outdoor and indoor location. Add an accent to any building architecture to draw attention. Enjoy ultrabright illumination with low temperature and low power consumption.

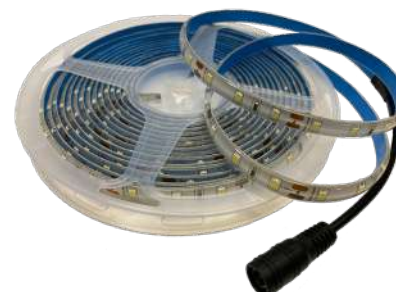

CE

Información Técnica / Technical Information

Especificaciones / Specifications

Código SKU	Descripción Description	Potencia Power (W)	TCC CCT (K)	Flujo Luminoso Luminous Flux (lm)	Tensión Voltage (V~)	Formato Format	IRC CRI
96576121A	CINTA LED KIT 5m 380lm/m	5W/m 25W	3000	380lm/m 1900lm	100-240 VAC	5 Metros	> 70
96576123A	CINTA LED KIT 5m 380lm/m	5W/m 25W	6500	380lm/m 1900lm		5 Metros	
96576120A	CINTA LED KIT 5m RGB	10W/m 50W	RGB	150lm/m 750lm		5 Metros	

Características / Features

- Chip de Led SMD 2835
- 60 Led SMD por metro rollo unico de 5m
- Cinta trasera autoadhesiva
- Tira LED cortable con 10cm y 16cm en RGB
- Driver de alimentación de 12V 1A: 12W

- Super bright 2835 SMD LED
- 60 SMD LEDs per meter / 5m reel
- Self-adhesive back tape
- Cutable Strip every 10 cm for single CCT / 16 cm RGB
- Power supply adapter 12V 1A:12w

Accesorios RGB / RGB accessories

Control RGB
Key remoteControlador RGB
RGB controllerCOMERCIOS
COMMERCESRESIDENCIAS
HOUSEHOLDSLIBRERÍAS
BOOK STORES

ILUKON FANTASY STRING LED



Características / Characteristics

Cadena 10 m con 15 bombillos led S14 UL de PC.
Puede unir hasta un máximo de 15 cadenas.
Bombillo extra para repuesto.



Información Técnica

Especificaciones / Specifications

Código Code	Descripción Description	Potencia Power (W)	TCC CCT (K)	Flujo Luminoso Luminous Flux (lm)	Tensión Voltage (V~)	IRC CRI	Base Base
95088150A	LUM FANTASY LED 15 LAMPS 822 10M	15 X 2W	2200	15 X 160 lm	120	80	E26

Dimensiones Generales

Modelo

95088150A

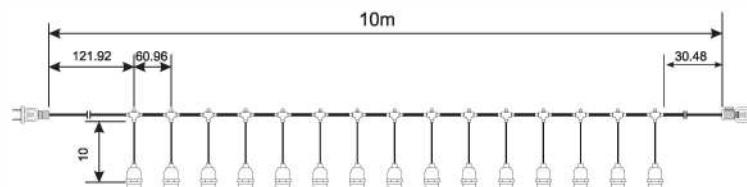

Información de empaque

Modelo Model	CBM (Master)	Unidades por caja Units per box	Dimensiones caja master (cm) Master Box dimensions	Peso (kg) Weight
95088150A	0.0834	6	57 X 48 X 30.5	10



COMERCIOS
COMMERCES



RESIDENCIAS
HOUSEHOLDS



LIBRERÍAS
BOOK STORES



ESCUELAS
SCHOOLS



OFICINAS
OFFICES



TIENDAS
STORES

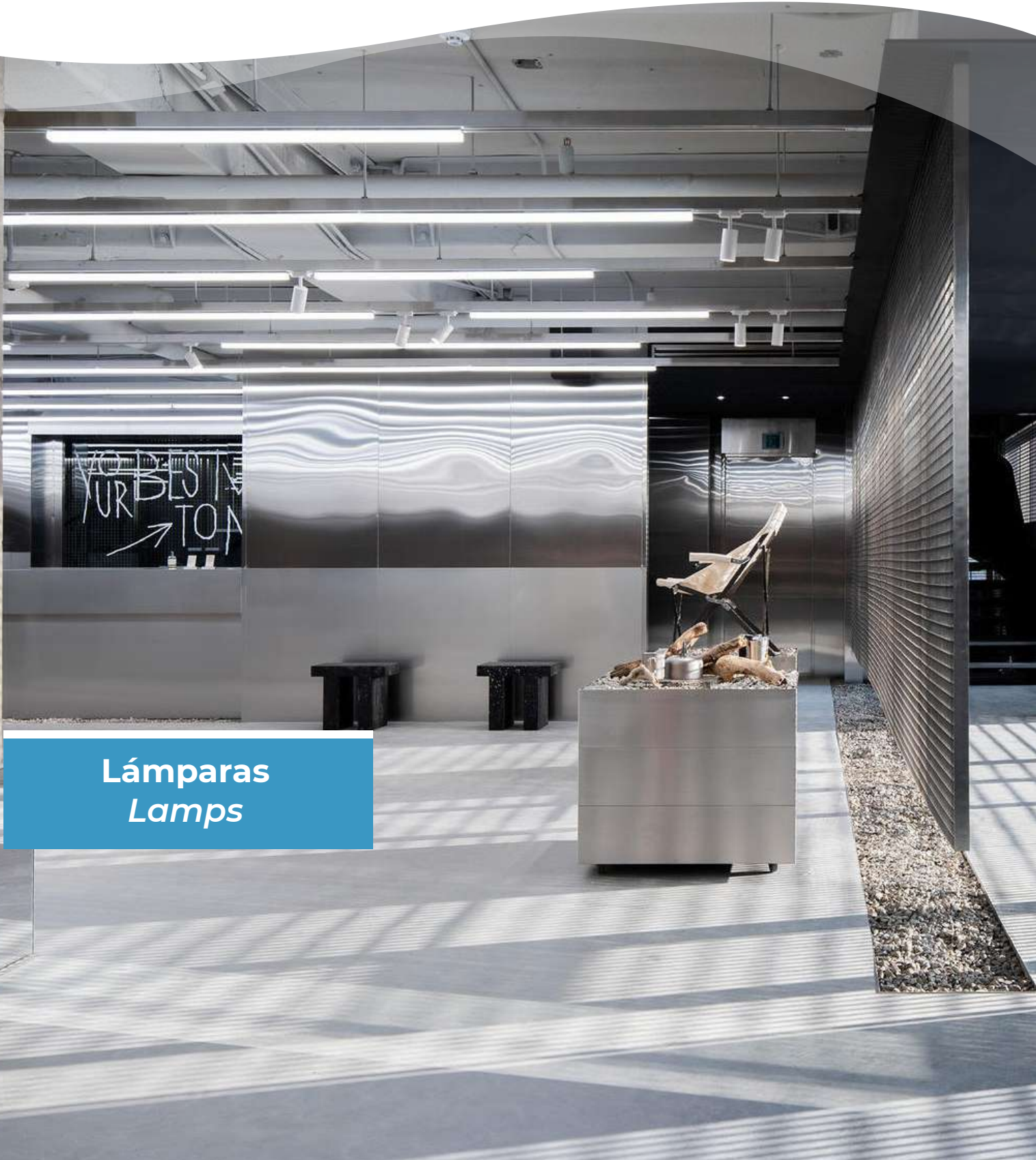

Lámparas
Lamps

Lámparas / Lamps

Páginas / Pages: 95-114



TUBO LED ILUKON 9W Y 18W CE **95**



TUBO LED ILUKON 9W **96**



TUBO LED ILUKON 18W **97**



TUBO LED ILUKON PC **98**



TUBO LED ILUKON T5 UL **99**



TUBO LED ILUKON T8 UL **100**



TUBO LED ILUKON 96 CE **101**



TUBO LED ILUKON 96 UL **102**



ILUKON BOMB LED CE **103**



ILUKON PRO LED A19 DIM **104**



ILUKON BOMB LED REFRI **105**



ILUKON B LED A60 SENSOR **106**



ILUKON B LED A60 EMERGEN **107**



ILUKON LED HIGH WATTAGE **108**



ILUKON PRO LED MR16 DIM **109**



ILUKON LED MR16 GU10 **110**



ILUKON LED MR16 GU5.3 **111**



ILUKON PRO LED PAR 20 DIM **112**



ILUKON PRO LED PAR 30 DIM **113**



ILUKON PRO LED PAR 38 DIM **114**

TUBO LED T8 ILUKON 9W y 18W CE



Características / Characteristics

Tubo LED de 9W y 18W de consumo, con apertura de 180 grados, carcasa de vidrio especialmente diseñada y conductividad térmica con excelente disipación del calor.

LED tube, 9W and 18W consumption, beam angle 180 degrees, Specially designed glass housing provides excellent transparency and thermal conductivity allowing good heat dissipation.



Información Técnica / Technical Information

Especificaciones / Specifications

Código SKU	Descripción Description	Potencia Power (W)	TCC CCT (K)	Flujo Luminoso Flux (lm)	Tensión Voltage (V~)	Formato Format	IRC CRI	Factor de Potencia PF	Eficacia Efficacy lm/w
23200908A	TUBO LED T8 9W 24" 900LM 120-240V 6500K	9	6500	900	120V-240V	24"	>70	>0.50	100
23201809A	TUBO LED T8 18W 48" 1600LM 120-240V 6500K	18		1600		48"		>0.50	88

Dimensiones Generales / General Dimensions

Código/ Code	Watts/ Watts	Largo/ Length	A	Unidades por Caja/ Units per Box
23200908A	9W	60cm	T8	25
23201809A	18W	120cm	T8	25

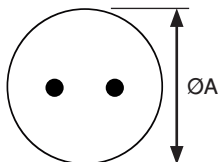

Conexión / Connection

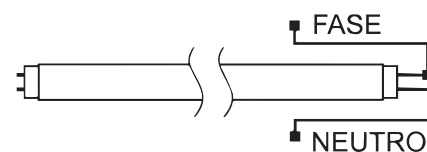

Descripción Tubo LED de uso general y alta eficiencia
Description LED Tube, for general use, high efficacy.

UTILIZAR SOLO BASES NO PREPUENTEADAS
USE ONLY NON-SHUNTED LAMPHOLDERS



COMERCIOS
COMMERCES



RESIDENCIAS
HOUSEHOLDS



LIBRERÍAS
BOOK STORES



ESCUELAS
SCHOOLS



OFICINAS
OFFICES



TIENDAS
STORES



FÁBRICAS
INDUSTRIES



HOSPITALES
HOSPITALS



BODEGAS/TALLERES
WAREHOUSES/ GARAGES



TUBO LED T8 ILUKON 9W



Características / Characteristics

Tubo LED de 9W de consumo, con apertura de 180 grados, carcasa de vidrio especialmente diseñada y conductividad termica con excelente disipación del calor.

LED tube, 9W consumption, beam angle 180 degrees, Specially designed glass housing provides excellent transparency and thermal conductivity allowing good heat dissipation.



Información Técnica / Technical Information

Especificaciones / Specifications

Código SKU	Descripción Description	Potencia Power (W)	TCC CCT (K)	Flujo Luminoso Flux (lm)	Tensión Voltage (V~)	Formato Format	IRC CRI	Factor de Potencia PF	Eficacia Efficacy lm/w
95057300A	TUBO LED T8 9W 24" 9L765 120-277V 25Khrs	9	6500	900	120V-277V	24"	>70	>0.90	100

Dimensiones Generales / General Dimensions

Código/ Code	Watts/ Watts	Largo/ Length	A	Unidades por Caja/ Units per Box
95057300A	9W	60cm	T8	20

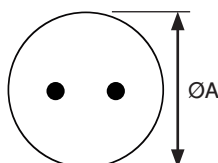

Conexión / Connection

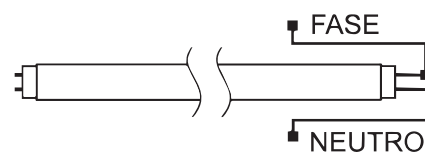

Descripción Tubo LED de uso general y alta eficiencia
Description LED Tube, for general use, high efficacy,

UTILIZAR SOLO BASES NO PREPUENTEADAS
USE ONLY NON-SHUNTED LAMPHOLDERS



COMERCIOS
COMMERCES



RESIDENCIAS
HOUSEHOLDS



LIBRERÍAS
BOOK STORES



ESCUELAS
SCHOOLS



OFICINAS
OFFICES



TIENDAS
STORES



FÁBRICAS
INDUSTRIES



HOSPITALES
HOSPITALS



BODEGAS/TALLERES
WAREHOUSES/ GARAGES



TUBO LED T8 ILUKON 18W



Características / Characteristics

Tubo LED de 18W de consumo, con apertura de 270 grados, carcasa de vidrio especialmente diseñada y conductividad térmica con excelente disipación del calor.

LED tube, 18W consumption, beam angle 270 degrees, Specially designed glass housing provides excellent transparency and thermal conductivity allowing good heat dissipation.



Información Técnica / Technical Information

Especificaciones / Specifications

Código SKU	Descripción Description	Potencia Power (W)	TCC CCT (K)	Flujo Luminoso Flux (lm)	Tensión Voltage (V~)	Formato Format	IRC CRI	Factor de Potencia PF	Eficacia Efficacy lm/w
232118640	TUBO LED T8 18W 48" 18L765 120-277V 25Khrs	18	6500	1800	120V-277V	48"	>80	>0.90	100

Dimensiones Generales / General Dimensions

Código/ Code	Watts/ Watts	Largo/ Length	A	Unidades por Caja/ Units per Box
232118640	18W	120cm	T8	30

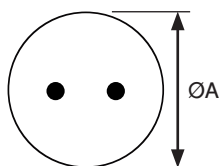

Conexión / Connection

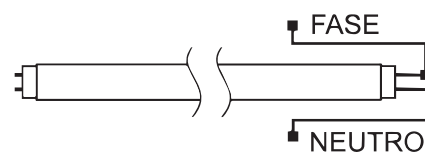

Descripción Tubo LED de uso general y alta eficiencia
Description LED Tube, for general use, high efficacy,

UTILIZAR SOLO BASES NO PREPUENTEADAS
USE ONLY NON-SHUNTED LAMPHOLDERS



COMERCIOS
COMMERCES



RESIDENCIAS
HOUSEHOLDS



LIBRERÍAS
BOOK STORES



ESCUELAS
SCHOOLS



OFICINAS
OFFICES



TIENDAS
STORES



FÁBRICAS
INDUSTRIES



HOSPITALES
HOSPITALS



BODEGAS/TALLERES
WAREHOUSES/ GARAGES



TUBO LED PC



Características / Characteristics

Tubo LED T8 con cuerpo de policarbonato opaco, Alimentación a un lado
 T8 LED Tube with PC Opal diffuser, Powered on one side



Información Técnica / Technical Information

Especificaciones / Specifications

Código SKU	Descripción Description	Potencia Power (W)	TCC CCT (K)	Flujo Luminoso Flux (lm)	Tensión Voltage (V~)	Formato Format	IRC CRI	Factor de Potencia PF	Eficacia Efficacy lm/w
23573073A	TUBO LED PC T8 ILUKON 48" 18L765 120-277V 18W	18	6500	1800	120V-277V	48"	>80	>0.50	100

Dimensiones Generales / General Dimensions

Código/ Code	Watts/ Watts	Largo/ Length	A	Unidades por Caja/ Units per Box
23573073A	18W	120cm	26mm	25

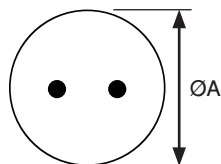

Conexión / Connection

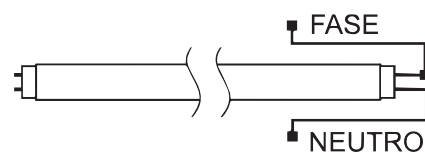

Descripción Tubo LED de uso general y alta eficiencia
Description LED Tube, for general use, high efficacy.

UTILIZAR SOLO BASES NO PREPUENTEADAS
 USE ONLY NON-SHUNTED LAMP HOLDERS





TUBO LED T5 25W UL



Características / Characteristics

Tubo LED T5 con opción de conexión a una base o a dos bases, sin balastro.
Cuerpo de vidrio opaco con cobertura PET.
Capacidad de atenuación en conexión a dos bases y a 120Vac.
Cumple con el estándar NSF-2.

*T5 Led tube power one end or two ends, without ballast.
PET coated - glass opal housing.
Dimming function only applicable in two end power and 120V.
Complies with NSF-2 Standard (safe for food industry).*



Información Técnica / Technical Information

		Especificaciones/ Specifications							
Código SKU	Descripción Description	Potencia Power (W)	TCC CCT (K)	Flujo Luminoso Flux (lm)	Tensión Voltage (V~)	Formato Format	IRC CRI	Eficacia Efficacy (lm/w)	
60571290A	TUBO LED T5 25W 120-277V 3500lm 850 50Khrs UL NSF DLC	25	5000	3500	120V-277V	45"	>83	140	

Dimensiones Generales / General Dimensions

Código/ Code	Largo/ Length	A
60571290A	1163 mm	T5

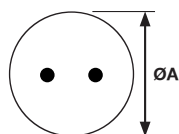

Conexión / Connection

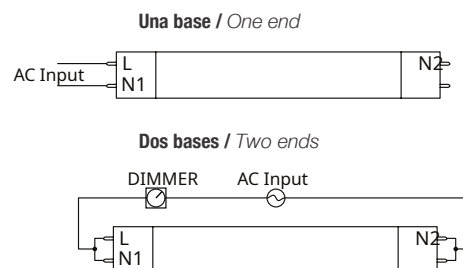

Información de empaque / Packing information

Modelo /Model	CBM (Master)	Unidades por caja /units per box	Dimensiones por caja /Box dimensions (cm)	Peso /Weight (kg)
25W	0.0216	25	122.3 x 13.3 x 13.3	7.5



COMERCIOS
COMMERCES



RESIDENCIAS
HOUSEHOLDS



LIBRERÍAS
BOOK STORES



ESCUELAS
SCHOOLS



OFICINAS
OFFICES



TIENDAS
STORES



FÁBRICAS
INDUSTRIES



HOSPITALES
HOSPITALS



BODEGAS/TALLERES
WAREHOUSES/ GARAGES

TUBO LED T8 ILUKON 18W UL



Características / Characteristics

Tubo LED de 18W de consumo, con apertura de 270 grados, carcasa de vidrio especialmente diseñada y conductividad termica con excelente disipación del calor.

LED tube, 18W consumption, beam angle 270 degrees, Specially designed glass housing provides excellent transparency and thermal conductivity allowing good heat dissipation.



Información Técnica / Technical Information

Especificaciones / Specifications

Código SKU	Descripción Description	Potencia Power (W)	TCC CGT (K)	Flujo Luminoso Flux (lm)	Tensión Voltage (V~)	Formato Format	IRC CRI	Factor de Potencia PF	Eficacia Efficacy lm/w
23201801A	TUBO LED T8 18W 48" 22L860 120-277V 50Khrs UL	18	6000	2200	120V-277V	48"	>80	>0.90	122

Dimensiones Generales / General Dimensions

Código/ Code	Watts/ Watts	Largo/ Length	A	Unidades por Caja/ Units per Box
23201801A	18W	120cm	T8	30

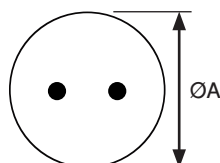

Conexión / Connection

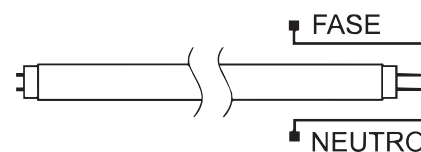

Descripción Tubo LED de uso general y alta eficiencia
Description LED Tube, for general use, high efficacy.

UTILIZAR SOLO BASES NO PREPUENTEADAS
USE ONLY NON-SHUNTED LAMP HOLDERS





TUBO LED T8 96" 40W



Características / Characteristics

Tubo LED de 96" para 40W de consumo, con apertura de 240 grados, carcasa de vidrio especialmente diseñada y conductividad térmica con excelente disipación del calor.

LED tube 96", 40W consumption, beam angle 240 degrees, Specially designed glass housing provides excellent transparency and thermal conductivity allowing good heat dissipation.



Información Técnica / Technical Information

Especificaciones / Specifications

Código SKU	Descripción Description	Potencia Power (W)	TCC CCT (K)	Flujo Luminoso Flux (lm)	Tensión Voltage (V~)	Formato Format	IRC CRI	Factor de Potencia PF	Eficacia Efficacy lm/w
23204008A	TUBO LED T8 40W 96" 40L865 120-277V 25Khrs CE	40	6500	4000	120V-277V	96"	>70	>0.50	100

Dimensiones Generales / General Dimensions

Código/ Code	Watts/ Watts	Largo/ Length	A	Unidades por Caja/ Units per Box
23204008A	40W	240cm	T8	10

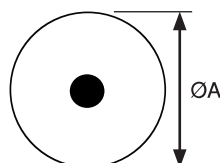

Conexión / Connection

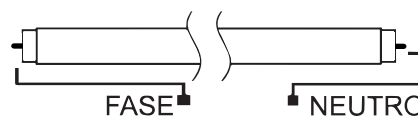

Descripción: Tubo LED de uso general y alta eficiencia.
Description: LED Tube, for general use, high efficacy.



TUBO LED T8 96" 36W UL



Características / Characteristics

Tubo LED de 96" para 36W de consumo, con apertura de 240 grados, carcasa de vidrio recubierto de PET.

LED tube 96", 36W consumption, beam angle 240 degrees, PET coated-glass housing



Información Técnica / Technical Information

Especificaciones / Specifications

Código SKU	Descripción Description	Potencia Power (W)	TCC CCT (K)	Flujo Luminoso Flux (lm)	Tensión Voltage (V~)	Formato Format	IRC CRI	Factor de Potencia PF	Eficacia Efficacy lm/w
23203608A	TUBO LED T8 36W 96" 45L865 120-277V 40Khrs PET NSF UL	36	6500	4500	120V-277V	96"	>83	>0.90	125

Dimensiones Generales / General Dimensions

Código/ Code	Watts/ Watts	Largo/ Length	A	Unidades por Caja/ Units per Box
23203608A	36W	240cm	T8	16

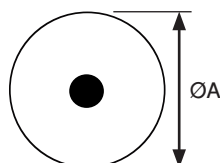

COMERCIOS
COMMERCES



RESIDENCIAS
HOUSEHOLDS



LIBRERÍAS
BOOK STORES



ESCUELAS
SCHOOLS



OFICINAS
OFFICES



TIENDAS
STORES



FÁBRICAS
INDUSTRIES



HOSPITALES
HOSPITALS



BODEGAS/TALLERES
WAREHOUSES/GARAGES



ILUKON BOMBILLO LED CE



Características / Characteristics

Bombillo LED de uso comercial o residencial, especialmente diseñado para dar un gran nivel de iluminación con un alto nivel de ahorro energético de hasta un 90% con respecto a otras tecnologías.

LED bulb for commercial or residential use, specially designed to give a high level of lighting with a high level of energy savings of up to 90% compared to other technologies.



Información Técnica / Technical Information

Especificaciones / Specifications

Código SKU	Descripción Description	Potencia Power (W)	TCC CCT (K)	Flujo Luminoso Flux (lm)	Base Base	Tensión Voltage (V~)	IRC CRI	Factor de Potencia PF	Eficacia Efficacy lm/w
95019060A	LED ILUKON A19 5L860 6W 15Khrs	6	6000	500	E27	120V	>80	>0.50	78
95019090A	LED ILUKON A19 9W-6000K-15Khrs	9		680		120V		>0.50	75
95001912A	LED ILUKON A19 10.55L860 12W 15Khrs	12		1055		120V		>0.50	87
95060150A	LED ILUKON A60 15W 13L865 15Khrs	15	3000	1300		120V		>0.50	86
95019093A	LED ILUKON A19 9W-3000K-15Khrs	9		700		120V		>0.50	77



COMERCIOS
COMMERCES



RESIDENCIAS
HOUSEHOLDS



LIBRERÍAS
BOOK STORES



ESCUELAS
SCHOOLS



OFICINAS
OFFICES



TIENDAS
STORES



FÁBRICAS
INDUSTRIES



HOSPITALES
HOSPITALS



BODEGAS/TALLERES
WAREHOUSES/ GARAGES



ILUKON PRO LED A19 DIM



Características / Characteristics

Bombillo LED de uso comercial o residencial, especialmente diseñado para dar un gran nivel de iluminación con un alto nivel de ahorro energético de hasta un 90% con respecto a otras tecnologías.

LED bulb for commercial or residential use, specially designed to give a high level of lighting with a high level of energy savings of up to 90% compared to other technologies.



Información Técnica / Technical Information

Especificaciones / Specifications

Código SKU	Descripción Description	Potencia Power (W)	TCC CCT (K)	Flujo Luminoso Flux (lm)	Base Base	Tensión Voltage (V~)	IRC CRI	Factor de Potencia PF	Eficacia Efficacy (lm/w)
95019098F	LED ILUKON F A19 9W 830 800lm DIM	9	3000	800	E27	120V	>80	>0.70	88
95019097F	LED ILUKON F A19 9W 860 800lm DIM	9	6000	800		120V		>0.70	88
95019153F	LED ILUKON F A19 12W 830 1050lm DIM	12	3000	1050		120V		>0.70	87
95019157F	LED ILUKON F A19 12W 860 1050lm DIM	12	6000	1050		120V		>0.70	87



COMERCIOS
COMMERCES



RESIDENCIAS
HOUSEHOLDS



LIBRERÍAS
BOOK STORES



ESCUELAS
SCHOOLS



OFICINAS
OFFICES



TIENDAS
STORES



FÁBRICAS
INDUSTRIES



HOSPITALES
HOSPITALS



BODEGAS/TALLERES
WAREHOUSES/ GARAGES



ILUKON BOMBILLO LED (REFRI)



Características / Characteristics

Bombillo LED para uso en refrigeradoras, especialmente diseñado para dar un gran nivel de iluminación con un alto nivel de ahorro energético de hasta un 90% con respecto a otras tecnologías,

LED bulb for use in refrigerators, specially designed to give a high level of lighting with a high level of energy savings of up to 90% compared to other technologies.



Información Técnica / Technical Information

Especificaciones / Specifications

Código SKU	Descripción Description	Potencia Power (W)	TCC CCT (K)	Flujo Luminoso Flux (lm)	Base Base	Tensión Voltage (V~)	IRC CRI	Factor de Potencia PF	Eficacia Efficacy (lm/w)
95015027A	BOMB LED ILUKON A15 4L827 120V E27 6W	6	2700	470	E27	120V	>80	>0.50	80
95714140A	BOMB LED ILUKON A15 4L865 120V E27 6W	6	6500	470		120V		>0.50	80

Dimensiones Generales / General Dimensions

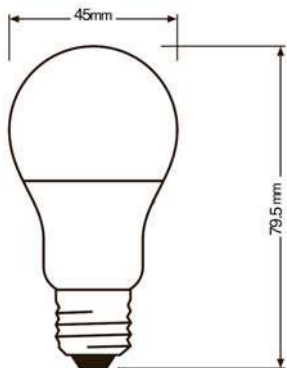

COMERCIOS
COMMERCES



RESIDENCIAS
HOUSEHOLDS



GLOBAL LIGHTING
SOLUTIONS
PROFESSIONAL LIGHTING



ILUKON
PROFESSIONAL LIGHTING



ILUKON BOMBILLO LED A60 SENSOR



Características / Characteristics

Bombillo LED con sensor de movimiento mediante microondas, con un rango de detección 4 a 6 metros de diámetro, contando con un grado IP20 y un uso recomendado de 10 a 12 horas por día en interiores.

LED bulb with microwave motion sensor, with a detection range of 4 to 6 meters in diameter, with an IP20 degree and a recommended use of 10 to 12 hours per day indoors.



Información Técnica / Technical Information

Especificaciones / Specifications

Código SKU	Descripción Description	Potencia Power (W)	TCC CCT (K)	Flujo Luminoso Flux (lm)	Base Base	Tensión Voltage (V~)	IRC CRI	Factor de Potencia PF	Eficacia Efficacy lm/w
95572331A	LED ILUKON A60 SENSOR 8L865 9W	9	6500	800	E27	120-240V	>80	>0.50	89



COMERCIOS
COMMERCES



RESIDENCIAS
HOUSEHOLDS



LIBRERÍAS
BOOK STORES



ESCUELAS
SCHOOLS



OFICINAS
OFFICES



TIENDAS
STORES



FÁBRICAS
INDUSTRIES



HOSPITALES
HOSPITALS



BODEGAS/TALLERES
WAREHOUSES/ GARAGES



ILUKON BOMBILLO LED A60 EMERGENCIA

GARANTÍA
WARRANTY

15.000h

ÁNGULO DE
APERTURACRI
IRCEFICACIA
EFFICACY

50/60 Hz

Características / Characteristics

Bombillo LED de emergencia, con una duración en modo de emergencia de 2 horas, contando con un grado IP20 y un uso recomendado de 10 a 12 horas por día en interiores.

Emergency LED bulb, with a duration in emergency mode of 2 hours, with an IP20 degree and a recommended use of 10 to 12 hours per day indoors.



Incluye accesorio para uso portátil /
Includes accessory for portable use.

Información Técnica / Technical Information

Especificaciones / Specifications

Código SKU	Descripción Description	Potencia Power (W)	TCC CCT (K)	Flujo Luminoso Flux (lm)	Base Base	Tensión Voltage (V~)	IRC CRI	Factor de Potencia PF	Eficacia Efficacy lm/w
95572405A	LED ILUKON A60 EMERGENCIA 8L865 9W	9	6500	810	E27	120-240V	>80	>0.50	90

COMERCIOS
COMMERCESRESIDENCIAS
HOUSEHOLDSLIBRERÍAS
BOOK STORESESCUELAS
SCHOOLSOFICINAS
OFFICESTIENDAS
STORESFÁBRICAS
INDUSTRIESHOSPITALES
HOSPITALSBODEGAS/TALLERES
WAREHOUSES/GARAGES

LED ILUKON HIGH WATTAGE



Características / Characteristics

Bombillo LED de alta potencia, con una gran salida luminosa, con un grado IP20 y un uso recomendado de 10 a 12 horas al día en interiores, con adaptador de base E27 / E40 para utilizar en múltiples aplicaciones.

High power LED bulb, with a great luminous output, with an IP20 degree and a recommended use of 10 to 12 hours a day indoors, with E27 / E40 base adapter to use in multiple applications.



Incluye accesorio para uso en Rosca E40 /
Includes accessory for use with E40 thread

Información Técnica / Technical Information

Especificaciones / Specifications

Código SKU	Descripción Description	Potencia Power (W)	TCC CCT (K)	Flujo Luminoso Flux (lm)	Base Base	Tensión Voltage (V~)	IRC CRI	Factor de Potencia PF	Eficacia Efficacy lm/w
95571463A	LED ILUKON HIGH WATTAGE 30W 65K 2700lm	30		2700		120-277V		>0.50	90
95571465A	LED ILUKON HIGH WATTAGE 40W 65K 3600lm	40	6500	3600	E27 con Adap E40	120-277V	>80	>0.50	90
95571462A	LED ILUKON HIGH WATTAGE 50W 65K 4500lm	50		4500		120-277V		>0.50	90

Dimensiones Generales / General Dimensions

Código/ Code	Watts/ Watts	A (mm)	B (mm)	Unidades por Caja/ Units per Box
95571463A	30W	100	176	20
95571465A	40W	117.5	203	20
95571462A	50W	117.5	203	20

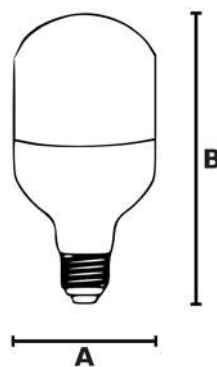

COMERCIOS
COMMERCES



RESIDENCIAS
HOUSEHOLDS



LIBRERÍAS
BOOK STORES



ESCUELAS
SCHOOLS



OFICINAS
OFFICES



TIENDAS
STORES



FÁBRICAS
INDUSTRIES



HOSPITALES
HOSPITALS



BODEGAS/TALLERES
WAREHOUSES/ GARAGES



ILUKON PRO LED MR16 DIM



GARANTÍA WARRANTY



25.000h



ÁNGULO DE APERTURA



CRI IRC



EFICACIA EFFICACY



50/60 HZ

Características / Characteristics

Bulbo LED tipo MR16 dimerizable, para instalación en bases tipo GU10, un uso recomendado de 10 a 12 horas por día en interiores.

Dimmable MR16 type LED bulb, for installation in GU10 type bases, a recommended use of 10 to 12 hours per day indoors.



Información Técnica / Technical Information

Especificaciones / Specifications

Código SKU	Descripción Description	Potencia Power (W)	TCC CCT (K)	Flujo Luminoso Flux (lm)	Base Base	Tensión Voltage (V~)	IRC CRI	Factor de Potencia PF	Eficacia Efficacy (lm/w)
95007300F	LED ILUKON MR16 7W 830 500lm 120V DIM GU10	7	3000	500	GU10	120V	>80	>0.70	71
95007500F	LED ILUKON MR16 7W 850 500lm 120V DIM GU10	7	5000	500		120V			



COMERCIOS
COMMERCES



RESIDENCIAS
HOUSEHOLDS



LIBRERÍAS
BOOK STORES



ESCUELAS
SCHOOLS



OFICINAS
OFFICES



TIENDAS
STORES



FÁBRICAS
INDUSTRIES



HOSPITALES
HOSPITALS



BODEGAS/TALLERES
WAREHOUSES/GARAGES

ILUKON LED MR16 GU10



Características / Characteristics

Bulbo LED tipo MR16 para instalación en bases tipo GU10, un uso recomendado de 10 a 12 horas por día en interiores.

MR16 type LED bulb, for installation in GU10 type bases, a recommended use of 10 to 12 hours per day indoors.

Información Técnica / Technical Information

Especificaciones / Specifications

Código SKU	Descripción Description	Potencia Power (W)	TCC CCT (K)	Flujo Luminoso Flux (lm)	Base Base	Tensión Voltage (V~)	IRC CRI	Factor de Potencia PF	Eficacia Efficacy lm/w
95016610A	LED ILUKON MR16 6W/830 120V 38° 500LM GU10	6	3000	500	GU10	120V	>80	>0.50	83



COMERCIOS
COMMERCES



RESIDENCIAS
HOUSEHOLDS



LIBRERÍAS
BOOK STORES



ESCUELAS
SCHOOLS



OFICINAS
OFFICES



TIENDAS
STORES



FÁBRICAS
INDUSTRIES



HOSPITALES
HOSPITALS



BODEGAS/TALLERES
WAREHOUSES/
GARAGES



ILUKON LED MR16 GU5.3



GARANTÍA WARRANTY



25.000h



ÁNGULO DE APERTURA



CRI IRC



EFICACIA EFFICACY



50/60 HZ



Características / Characteristics

Bulbo LED tipo MR16, para instalación en bases tipo GU5.3, un uso recomendado de 10 a 12 horas por día en interiores.

MR16 type LED bulb, for installation in GU5.3 type bases, a recommended use of 10 to 12 hours per day indoors.

Información Técnica / Technical Information

Especificaciones / Specifications

Código SKU	Descripción Description	Potencia Power (W)	TCC CCT (K)	Flujo Luminoso Flux (lm)	Base Base	Tensión Voltage (V~)	IRC CRI	Factor de Potencia PF	Eficacia Efficacy lm/w
95016653A	LED ILUKON MR16 6W/830 120V 38* 500LM GU5.3	6	3000	500	GU5.3	120V	>80	>0.50	83

COMERCIOS
COMMERCESRESIDENCIAS
HOUSEHOLDSLIBRERÍAS
BOOK STORESESCUELAS
SCHOOLSOFICINAS
OFFICESTIENDAS
STORESFÁBRICAS
INDUSTRIESHOSPITALES
HOSPITALSBODEGAS/TALLERES
WAREHOUSES/GARAGES



ILUKON PRO LED PAR 20 DIM



Características / Characteristics

Bombillo LED tipo PAR 20 de uso comercial o residencial, especialmente diseñado para dar un gran nivel de iluminación con un alto nivel de ahorro energético de hasta un 90% con respecto a otras tecnologías, para uso en rosca E27.

PAR 20 type LED bulb for commercial or residential use, specially designed to give a high level of lighting with a high level of energy savings of up to 90% compared to other technologies, for use in E27 base.



Información Técnica / Technical Information

Especificaciones / Specifications									
Código SKU	Descripción Description	Potencia Power (W)	TCC CCT (K)	Flujo Luminoso Flux (lm)	Base Base	Tensión Voltage (V~)	IRC CRI	Factor de Potencia PF	Eficacia Efficacy (lm/w)
95020070F	LED ILUKON PAR20 7W 830 500lm 120V DIM	7	3000	500	E27	120V	>80	>0.90	71
95002007F	LED ILUKON PAR20 7W 850 500lm 120V DIM	7	5000	500		120V			71





ILUKON PRO LED PAR 30 DIM



Características / Characteristics

Bombillo LED tipo PAR 30 de uso comercial o residencial, especialmente diseñado para dar un gran nivel de iluminación con un alto nivel de ahorro energético de hasta un 90% con respecto a otras tecnologías, para uso en rosca E27.

PAR 30 type LED bulb for commercial or residential use, specially designed to give a high level of lighting with a high level of energy savings of up to 90% compared to other technologies, for use in E27 base.

Información Técnica / Technical Information

Especificaciones / Specifications

Código SKU	Descripción Description	Potencia Power (W)	TCC CCT (K)	Flujo Luminoso Flux (lm)	Base Base	Tensión Voltage (V~)	IRC CRI	Factor de Potencia PF	Eficacia Efficacy lm/w
95030120F	LED ILUKON PAR30LN 11W 830 950lm 120V DIM	11	3000	950	E27	120V	>80	>0.90	79
95003012F	LED ILUKON PAR30LN 11W 850 950lm 120V DIM	11	5000	950		120V			



COMERCIOS
COMMERCES



RESIDENCIAS
HOUSEHOLDS



LIBRERÍAS
BOOK STORES



ESCUELAS
SCHOOLS



OFICINAS
OFFICES



TIENDAS
STORES



FÁBRICAS
INDUSTRIES



HOSPITALES
HOSPITALS



BODEGAS/TALLERES
WAREHOUSES/GARAGES



ILUKON PRO LED PAR 38 DIM



Características / Characteristics

Bombillo LED tipo PAR 38 de uso comercial o residencial, especialmente diseñado para dar un gran nivel de iluminación con un alto nivel de ahorro energético de hasta un 90% con respecto a otras tecnologías, para uso en rosca E27.

PAR 38 type LED bulb for commercial or residential use, specially designed to give a high level of lighting with a high level of energy savings of up to 90% compared to other technologies, for use in E27 base.



Información Técnica / Technical Information

Especificaciones / Specifications

Código SKU	Descripción Description	Potencia Power (W)	TCC CCT (K)	Flujo Luminoso Flux (lm)	Base Base	Tensión Voltage (V~)	IRC CRI	Factor de Potencia PF	Eficacia Efficacy lm/w
95003815F	LED ILUKON PAR38 15W 830 1300lm 120V DIM	15	3000	1300	E27	120V	>80	>0.90	87
95038150F	LED ILUKON PAR38 15W 850 1300lm 120V DIM	15	5000	1300		120V			



COMERCIOS
COMMERCES



RESIDENCIAS
HOUSEHOLDS



LIBRERÍAS
BOOK STORES



ESCUELAS
SCHOOLS



OFICINAS
OFFICES



TIENDAS
STORES



FÁBRICAS
INDUSTRIES



HOSPITALES
HOSPITALS



BODEGAS/TALLERES
WAREHOUSES/GARAGES



**Accesorios de
Emergencia**
*Emergency
Accessories*

Accesorios de Emergencia / Emergency Accessories

Páginas / Pages: 117-121



BATERÍA EMERGENCIA P/ LED 8W **117**



BATERÍA EMERGENCIA P/ LED 20W **118**



BATERÍA EMERGENCIA P/ LED 20W MÁX **119**



BATERÍA EMERGENCIA P/ LED 40W **120**



BATERÍA EMERGENCIA P/ HIGHBAY LED 200W **121**



BATERÍA EMERGENCIA P/ LED 8W



Características / Characteristics

Batería de Emergencia de potencia constante, proporcionando potencia constante a la Luminaria LED, evitando la degradación de la iluminación de emergencia para el tiempo de ejecución requerido durante 90 minutos. Recomendada para espacios internos y de fácil instalación.

Constant power emergency battery, constant power power at the LED Luminaire, preventing the degradation of the emergency lighting for the required execution time of 90 minutes. Recommended for internal spaces and easy to install.



Información de Producto / Product Information

Código SKU	Descripción Description	Frecuencia Frequency	Tensión Voltage (V~)
90580850A	BATERÍA EMERGENCIA P/ LED 8W 90 MIN 120-277V UL	50-60Hz	120-277 VAC

Información Técnica / Technical Information

- Carcasa de acero resistente y duradera / Strong and durable steel housing
- Operación de emergencia de 90 minutos / 90 minute emergency operation
- Máximo de 24 horas para el tiempo de recarga completa / Maximum 24 hours for full recharge time
- Interruptor de prueba e indicador de carga / Test switch and charge
- Modo de operación: Para trabajar solo dentro de la luminaria / Mode of Operation: Works with internal driver fixtures only
- Potencia de entrada 5.5W / Input Wattage 5.5W
- Corriente de entrada 40-50mA / Input Current 40-50mA
- Voltaje de salida 3-60VDC / Output Voltage 3-60VDC
- Potencia de salida 8W máx. / Output Power 8W Max
- Batería 6V4000mAh Ni-Cad / Battery 6V4000mAh Ni-Cad
- Corriente de carga máxima (mA) 420mA / Max Charge Current (mA) 420mA
- Corriente máxima de descarga (mA) 2200mA / Max Discharge Current (mA) 2200mA
- Salida luminosa 8 lm/W de la luminaria / Lumen Output 8 lm/W of the fixture
- Temperatura de funcionamiento 0°C - 50°C / Working Temperature 0°C - 50°C

Dimensiones Generales / General Dimensions

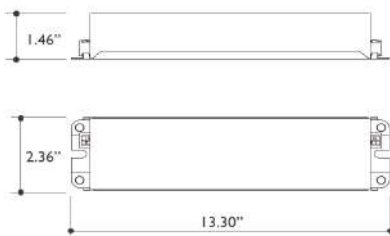

Model	Packing information	Housing Color
90580850A	40 x 25 x 15.5 cm / 6 pcs per master / G.W. 8.3 / N.W. 7.3KGS	White

FÁBRICAS
INDUSTRIESLIBRERÍAS
BOOK STORESBODEGAS/TALLERES
WAREHOUSES/GARAGESESCUELAS
SCHOOLSAEROPUERTOS
AIRPORTSESTACIONAMIENTOS
PARKING LOT

Diagrama de Conexión / Wiring Diagram

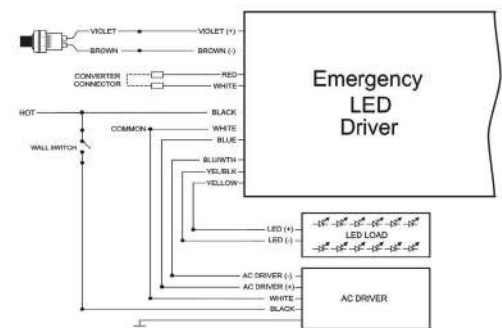

BATERÍA EMERGENCIA P/ LED 20W



Características / Characteristics

Batería de Emergencia de potencia constante, proporcionando potencia constante a la Luminaria LED, evitando la degradación de la iluminación de emergencia para el tiempo de ejecución requerido durante 90 minutos. Recomendada para espacios internos y de fácil instalación.

Constant power emergency battery, constant power power at the LED Luminaire, preventing the degradation of the emergency lighting for the required execution time of 90 minutes. Recommended for internal spaces and easy to install.



Información de Producto / Product Information

Código SKU	Descripción Description	Frecuencia Frequency	Tensión Voltage (V~)
90585034A	BATERÍA EMERGENCIA P/ LED 20W 90 MIN 120-277V CE	50-60Hz	120-277 VAC

Las baterías deben instalarse dentro de un año. Las baterías deben probarse y recargarse al menos una vez cada 6 meses para mantener el funcionamiento adecuado y evitar la pérdida de la garantía. Batteries should be installed within a year. Batteries must be tested and recharged at least once every 6 months to maintain proper function and avoid loss of warranty.

Información Técnica / Technical Information

- Carcasa de plástico ABS resistente y duradera / Strong and durable ABS Plastic housing
- Operación de emergencia de 90 minutos / 90 minute emergency operation
- Máximo de 24 horas para el tiempo de recarga completa / Maximum 24 hours for full recharge time
- Interruptor de prueba e indicador de carga / Test switch and charge
- Modo de operación: Para trabajar solo dentro de la luminaria / Mode of Operation: Works with internal driver fixtures only
- Potencia de entrada 6.5W / Input Wattage 6.5W
- Corriente de entrada 55mA máx / Input Current 55mA max
- Voltaje de salida 110-180VDC (120VAC) / Output Voltage 110-180VDC (120VAC)
- Potencia de salida 20W máx. / Output Power 20W Max
- Batería 11.1V4000mAh Li-ion / Battery 11.1V4000mAh Li-ion
- Corriente de carga máxima (mA) 350mA / Max Charge Current (mA) 350mA
- Corriente máxima de descarga (mA) 2500mA / Max Discharge Current (mA) 2500mA
- Salida luminosa 100% / Lumen Output 100%
- Temperatura de funcionamiento 0°C - 40°C / Working Temperature 0°C - 40°C

Dimensiones Generales / General Dimensions



Diagrama de Conexión / Wiring Diagram



Model	Packing information
90585034A	30.5 x 23.5 x 16.5 cm / 6 pcs per master / G.W. 5.3 / N.W. 4.3KGS



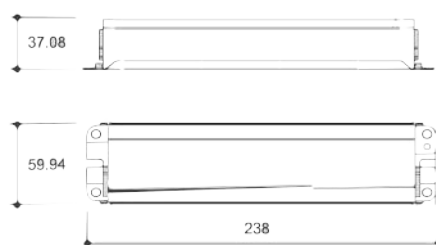
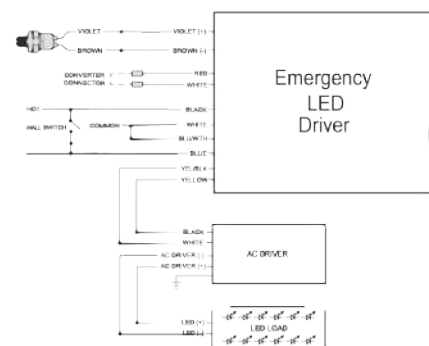

BATERÍA EMERGENCIA P/ LED 20W MÁX



Características / Characteristics

Batería de Emergencia de potencia constante, proporcionando potencia constante a la Luminaria LED, evitando la degradación de la iluminación de emergencia para el tiempo de ejecución requerido durante 90 minutos. Recomendada para espacios internos y de fácil instalación.

Constant power emergency battery, constant power power at the LED Luminaire, preventing the degradation of the emergency lighting for the required execution time of 90 minutes. Recommended for internal spaces and easy to install.



Información de Producto / Product Information

Código SKU	Descripción Description	Frecuencia Frequency	Tensión Voltage (V~)
90585024A	BATERÍA EMERGENCIA P/ LED MAX 20W 90 MIN 120-277V UL	50-60Hz	120-277 VAC

Información Técnica / Technical Information

- Carcasa de acero resistente y duradera / Strong and durable steel housing
- Operación de emergencia de 90 minutos / 90 minute emergency operation
- Máximo de 24 horas para el tiempo de recarga completa / Maximum 24 hours for full recharge time
- Interruptor de prueba e indicador de carga / Test switch and charge
- Modo de operación: Para trabajar solo dentro de la luminaria / Mode of Operation: Works with internal driver fixtures only
- Potencia de entrada 5.5W / Input Wattage 5.5W
- Corriente de entrada 85-65mA / Input Current 85-65mA
- Voltaje de salida 180-320VDC (120-230VAC) / Output Voltage 180-320VDC (120-230VAC)
- Potencia de salida 20W máx. / Output Power 20W Max
- Batería 114.4V4000mAh Ni-Cad / Battery 14.4V4000mAh Ni-Cad
- Corriente de carga máxima (mA) 190mA / Max Charge Current (mA) 190mA
- Corriente máxima de descarga (mA) 1700mA / Max Discharge Current (mA) 1700mA
- Salida luminosa 100% / Lumen Output 100%
- Temperatura de funcionamiento 0°C - 50°C / Working Temperature 0°C - 50°C
- Cumple con los códigos de UL 924, NFPA 101, NEC, OSHA, códigos locales y estatales. / Complies with UL 924, NFPA 101, NEC, OSHA, local and state codes.

Dimensiones Generales / General Dimensions

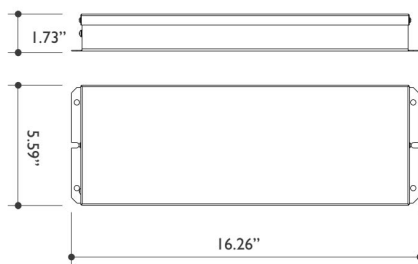

Modelo / Model	Información de empaque / Packing Information	Opciones / Options
90585024A	28.5 x 22.5 x 24 cm / 6 pcs por caja maestra / G.W. 19.9 / N.W. 15.9 KGS	Carcasa Color: Blanco / Rojo



Diagrama de Conexión / Wiring Diagram

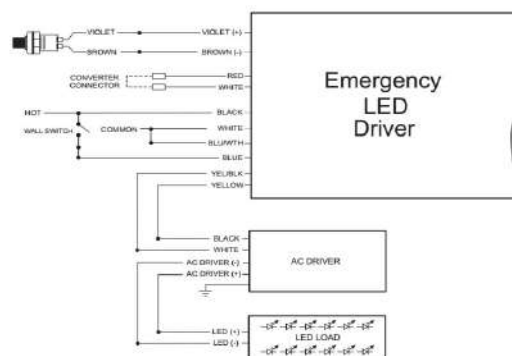

BATERÍA EMERGENCIA P/ LED 40W



Características / Characteristics

Batería de Emergencia de potencia constante, proporcionando potencia constante a la Luminaria LED, evitando la degradación de la iluminación de emergencia para el tiempo de ejecución requerido durante 90 minutos. Recomendada para espacios internos y de fácil instalación.

Constant power emergency battery, constant power power at the LED Luminaire, preventing the degradation of the emergency lighting for the required execution time of 90 minutes. Recommended for internal spaces and easy to install.



Información de Producto / Product Information

Código SKU	Descripción Description	Frecuencia Frequency	Tensión Voltage (V~)
90585026A	BATERÍA EMERGENCIA P/ LED MAX 40W 90 MIN 120-277V	50-60Hz	120-277 VAC

Información Técnica / Technical Information

- Carcasa de acero resistente y duradera / Strong and durable steel housing
- Batería LiFePo4 incorporada / Built-in LiFePo4 battery
- Operación de emergencia de 90 minutos / 90 minute emergency operation
- Máximo de 24 horas para el tiempo de recarga completa / Maximum 24 hours for full recharge time
- Interruptor de prueba e indicador de carga / Test switch and charge
- Modo de operación: Para trabajar solo dentro de la luminaria / Mode of Operation: Works with internal driver fixtures only
- Potencia de entrada 6.5W / Input Wattage 6.5W
- Corriente de entrada 85-65mA / Input Current 85-65mA
- Voltaje de salida 110-180 V CC (120 V CA) / Output Voltage 110-180VDC (120VAC)
- Potencia de salida 40W máx. / Output Power 40W Max
- Batería 11.1V7000mAh Li-Ion / Battery 11.1V7000mAh Li-Ion
- Corriente de carga máxima (mA) 350mA / Max Charge Current (mA) 350mA
- Corriente máxima de descarga (mA) 5000mA / Max Discharge Current (mA) 5000mA
- Salida luminosa 100% / Lumen Output 100%
- Temperatura de funcionamiento 0°C - 50°C / Working Temperature 0°C - 50°C

Dimensiones Generales / General Dimensions



Diagrama de Conexión / Wiring Diagram

FÁBRICAS
INDUSTRIESLIBRERÍAS
BOOK STORESBODEGAS/TALLERES
WAREHOUSES/GARAGESESCUELAS
SCHOOLSAEROPUERTOS
AIRPORTSESTACIONAMIENTOS
PARKING LOT



BATERÍA EMERGENCIA P/ HIGHBAY LED 200W

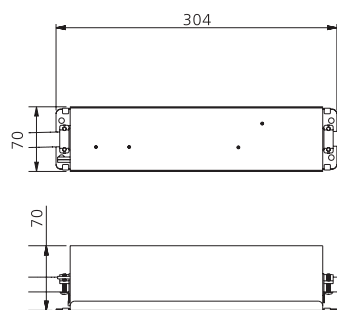
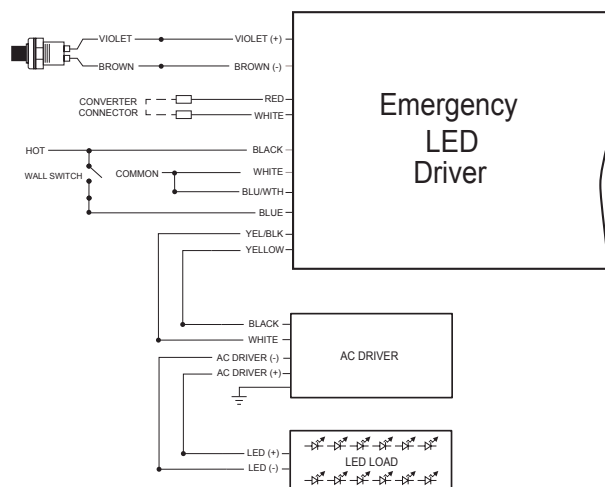

Características / Characteristics

Batería de Emergencia de potencia constante, ideal para lum inarias Highbay tipo UFO de 200W o menos
Autonom ía de 90 minutos
Cumple con UL924 y CSA 22.2

*Constant power emergency battery, for use with UFO highbay 200W or less
90 minutes autonomy
Comply UL924 and CSA 22.2*



Información de Producto / Product Information

Código Code	Descripción Description	Tensión de entrada Input Voltage	Tensión de salida Output Voltage	Potencia de entrada Input Wattage	Potencia de salida Output Wattage	Corriente de entrada Input Current	Peso Weight	Dimensiones Dimensions
50674272A	BATERÍA EMERGENCIA HIGHBAY MAX 200W	120-277 V~	170 Vdc	15 W	40 W	<200 mA	3,3 kg	273,26*ø142,3 mm

Información Técnica / Technical Information

- Carcasa de acero resistente y duradera / *Strong and durable steel housing*
- Operación de emergencia de 90 minutos / *90 minute emergency operation*
- Máxim o de 24 horas para el tiempo de recarga com pleta / *Maximum 24 hours for full recharge time*
- Interruptor de prueba e indicador de carga / *Test switch and charge*
- Batería Li-Ion / *Li-Ion Battery*
- Tem peratura de funcionam iento 5°C - 50°C / *Working Temperature 5°C - 50°C*

Diagrama de Conexión / Wiring Diagram

Con atenuador / With dimmer

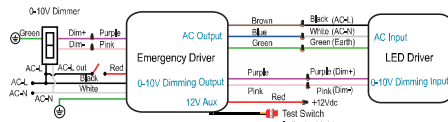

Con sensor 120-277V / With 120-277V sensor



Con interruptor sin atenuador / With wall switch without dimmer

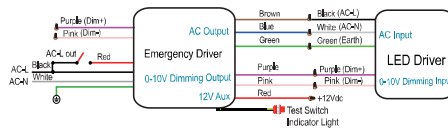

Con sensor 12 Vdc / With 12 Vdc sensor

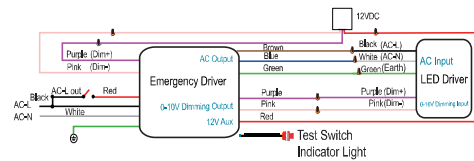

Sin interruptor o atenuador / Without wall switch or dimmer

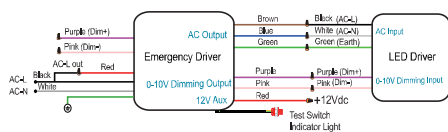





ANEXOS / APPENDIX



Medidas y Diámetros / Measurements and diameters

Diámetros de tubos Diameter		Dimensiones Dimensions	Potencia de tubos fluorescentes Power fluorescents (W)	Equivalencia en tubos Led Equivalence Led Tubes (W)
T5		5/8" = 15,9mm	24"	14W 21W 24W
			48"	28W 54W
T8		8/8" = 25,4mm	24"	17W
			48"	32W
			96"	59W
T12		12/8" = 38,1mm	24"	20W
			48"	40W
			96"	75W
				N.A.

Temperatura de color correlacionada (TCC) / Correlated color temperature (CCT)

La temperatura de color de una fuente de luz, es la comparación de su color dentro del espectro luminoso y la temperatura del objeto modelado a través de la luz que emitiría un cuerpo negro calentado. En otras palabras, es la apariencia visual del color de la luz.

La calificación TCC de una luz es, en términos generales, una medida de "calidez" o "frialidad" de su apariencia.

Se expresa en Kelvin (K), que es una medida absoluta de temperatura, a pesar de que TCC es una medida para la temperatura relativa.

The color temperature of a light source is the temperature of object modeled through a black body radiator that radiates light of a color comparable to that of the light source. In other words, is the visual appearance of color of the light.

The CCT rating for a light is in general terms "warmth" or "coolness" measure of its appearance.

It is conventionally expressed in Kelvin (K) which is a unit of measure for absolute temperature, even when CCT is a measure for relative temperature.

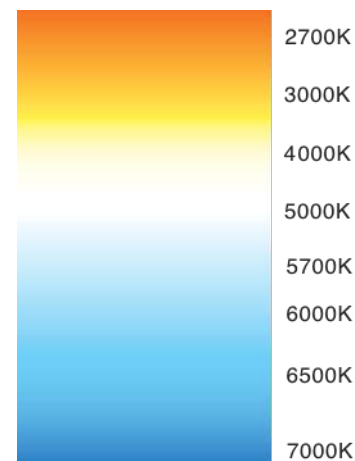

Índice de reproducción del color (IRC) / Color rendering index (CRI)

El índice de reproducción del color mide la capacidad que tiene una fuente de luz para reproducir colores de objetos en contrastes con una fuente de luz de referencia natural, como lo es el sol.

Cada tipo de iluminación puede cuantificarse de acuerdo a una tabla de reproducción de color. Esta tabla mide en una escala de 0 a 100, dependiendo de la precisión con la que se pueda reproducir la luz, donde 100 representa la capacidad más alta de reproducir la luz natural.

Color rendering index measures the ability of a light source to reproduce colors of objects in contrast to a naturally referenced light source such as the sun.

Every type of lighting has its place on what's known as the color rendering index chart. This chart measures a scale from 0 to 100, depending on how accurately it can produce light that matches as the sun, where 100 represents the highest ability.

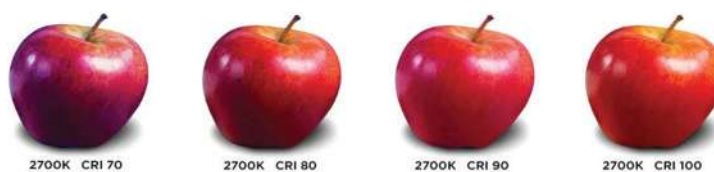

Grado IP de Protección / IP Grade

El grado de protección IP se refiere a la norma internacional CEI 60529, que clasifica de manera alfanumérica a los equipos y productos, en cuanto al nivel de protección que sus materiales le proporcionan respecto a polvo y agua.

Se determina mediante la composición del acrónimo "IP" (protección de ingreso en sus siglas en inglés) más el primer dígito que se refiere al nivel de protección ante ingreso de partículas sólidas y el segundo dígito al nivel de protección frente a ingreso de líquidos. Entre más alto sea el valor numérico de cada dígito, mayor será el grado de protección.

IP Code is defined in IEC standard 60529 which alphanumerically classifies equipment and products in terms of degrees of protection provided against dust and water.

It is a two-digit code, determined by the composition of the acronym IP (Ingress Protection), the first digit represents protection against ingress of solid objects and the second digit represents protection against ingress of liquids. The larger the value of each digit, the greater the protection.

Protección de entrada

Ingress Protection

IP67

Protección ante el polvo

Protection against ingress of dust

Protección frente a líquidos

Protection against ingress of liquids

0	Sin protección particular <i>No protection against ingress of solid objects</i>
1	Protegida contra cuerpos sólidos de más de 50mm <i>Protected against solid objects over 50mm</i>
2	Protegida contra cuerpos sólidos de más de 12mm <i>Protected against solid objects over 12mm</i>
3	Protegida contra cuerpos sólidos de más de 2.5mm <i>Protected against solid objects over 2.5mm</i>
4	Protegida contra cuerpos sólidos de más de 1mm <i>Protected against solid objects over 1mm</i>
5	Protegida contra penetración de polvo <i>Protected against dust limited ingress, no harmful deposit</i>
6	Ninguna entrada de polvo <i>No ingress of dust; complete protection against contact</i>

0	Sin protección particular <i>No protection against ingress of liquids</i>
1	Caída vertical de gotas de agua <i>Protected against vertically falling drops</i>
2	Caída de gotas de agua con inclinación máxima de 15° <i>Protected against direct sprays of liquids up to 15 degrees from the vertical</i>
3	Contra lluvia <i>Protected against direct sprays of liquids up to 60 degrees from the vertical</i>
4	Contra proyección de agua en todas direcciones <i>Protected against liquid splashed from all directions</i>
5	Contra chorros de agua <i>Protected against low pressure jets of liquids from all directions</i>
6	Contra fuertes chorros de agua <i>Protected against strong jets of liquids</i>
7	Contra efectos de la inmersión temporal <i>Protected against immersed in liquids under defined conditions of pressure and time</i>
8	Contra los efectos de la inmersión prolongada <i>Hermetically sealed, it is suitable for continuous immersion of liquids</i>

Grado IK de Protección / IK Grade

El grado de protección IK es una clasificación internacional que indica el grado de protección del material exterior del equipo eléctrico contra choques mecánicos. El producto debe resistir un impacto mecánico sin alterar el funcionamiento eléctrico ni el grado de protección IP. IK02 corresponde a una protección normal, IK07 a una protección extra y el IK10 es resistente al vandalismo.

IK ratings are an international numeric classification to indicate the degrees of protection provided by enclosures for electrical equipment against external mechanical impacts. The product must withstand a mechanical impact without altering the electrical function or the IP degree. IK02 corresponds to normal protection, IK07 to extra protection and IK10 is resistant to vandalism.

Grado IK IK Grade	Energía Energy (Joules)	Masa de la pieza que golpeó Mass dropped
K100	Sin Proteger / WO Protection	-
IK01	0,15	0.2 Kg / 70 mm
IK02	0,20	0.2 Kg / 100 mm
IK03	0,35	0.2 Kg / 175 mm
IK04	0,50	0.2 Kg / 250 mm
IK05	0,70	0.2 Kg / 350 mm
IK06	1,00	0.5 Kg / 200 mm
IK07	2,00	0.5 Kg / 400 mm
IK08	5,00	1.7 Kg / 295 mm
IK09	10,00	5.0 Kg / 200 mm
IK10	20,00	5.0 Kg / 400 mm

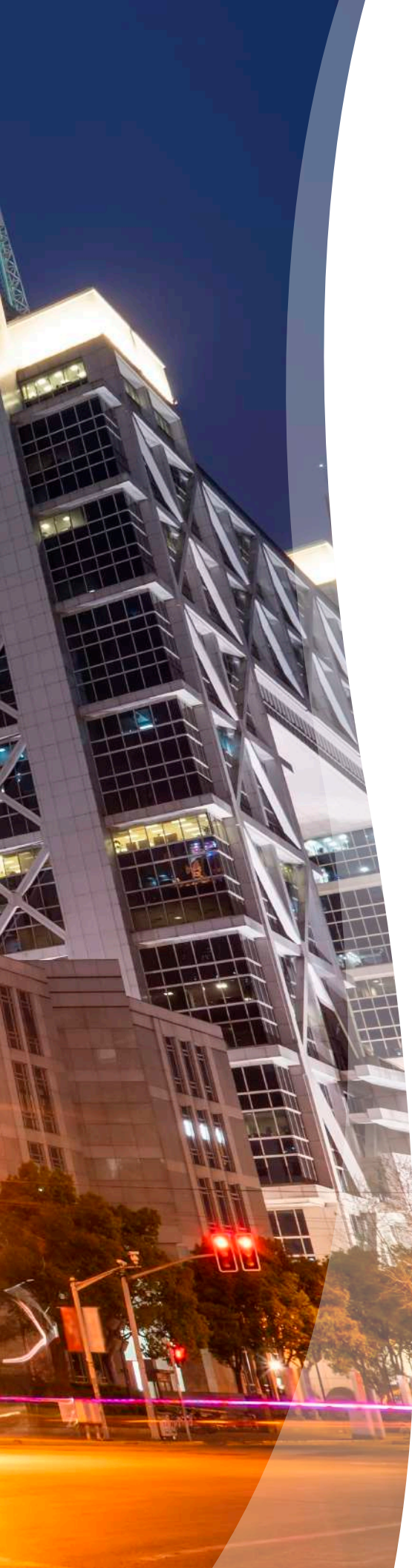

@gls-ca.com

📍 Oficinas centrales: Plaza Obelisco #13, Río Oro, Santa Ana, Costa Rica.
Plaza Obelisco suite 13. Río Oro, Santa Ana, Costa Rica.

+506 2203-3939
+506 4001-5352

gls-ca.com



GLS Global Lighting Solutions e Ilukon son marcas registradas de Global Lighting Solutions S.A.

Reservados todos los derechos 2024-2025. GLS se reserva el derecho de modificar las especificaciones o discontinuar cualquier producto de este catálogo sin notificación previa y no será responsable de ninguna consecuencia que resulte de esta publicación.

GLS Global Lighting Solutions e Ilukon are registered trademarks of Global Lighting Solutions S.A.

All rights reserved 2024-2025. Product availability, specifications and compliances are subject to change without notice and will not be responsible for any consequences resulting for this publication.